



Republic of the Philippines  
**Department of Education**  
REGION VII – central visayas  
SCHOOLS DIVISION OF NEGROS ORIENTAL

# **PHILIPPINE BIDDING DOCUMENTS**

**CY 2022 Quick Response Fund (QRF) New  
Construction of School Buildings for Schools  
Affected by Calamities, Epidemics, Crises, &  
Catastrophes - Lot 2 (Manjuyod Central  
Elementary School, Negros Oriental)**

ITB 2023-02-026

Government of the Republic of the Philippines

**Sixth Edition  
July 2020**

# Preface

These Philippine Bidding Documents (PBDs) for the procurement of Infrastructure Projects (hereinafter referred to also as the “Works”) through Competitive Bidding have been prepared by the Government of the Philippines for use by all branches, agencies, departments, bureaus, offices, or instrumentalities of the government, including government-owned and/or -controlled corporations, government financial institutions, state universities and colleges, local government units, and autonomous regional government. The procedures and practices presented in this document have been developed through broad experience, and are for mandatory use in projects that are financed in whole or in part by the Government of the Philippines or any foreign government/foreign or international financing institution in accordance with the provisions of the 2016 revised Implementing Rules and Regulations (IRR) of Republic Act (RA) No. 9184.

The PBDs are intended as a model for admeasurements (unit prices or unit rates in a bill of quantities) types of contract, which are the most common in Works contracting.

The Bidding Documents shall clearly and adequately define, among others: (i) the objectives, scope, and expected outputs and/or results of the proposed contract; (ii) the eligibility requirements of Bidders; (iii) the expected contract duration; and (iv) the obligations, duties, and/or functions of the winning Bidder.

Care should be taken to check the relevance of the provisions of the PBDs against the requirements of the specific Works to be procured. If duplication of a subject is inevitable in other sections of the document prepared by the Procuring Entity, care must be exercised to avoid contradictions between clauses dealing with the same matter.

Moreover, each section is prepared with notes intended only as information for the Procuring Entity or the person drafting the Bidding Documents. They shall not be included in the final documents. The following general directions should be observed when using the documents:

- a. All the documents listed in the Table of Contents are normally required for the procurement of Infrastructure Projects. However, they should be adapted as necessary to the circumstances of the particular Project.
- b. Specific details, such as the “*name of the Procuring Entity*” and “*address for bid submission*,” should be furnished in the Instructions to Bidders, Bid Data Sheet, and Special Conditions of Contract. The final documents should contain neither blank spaces nor options.
- c. This Preface and the footnotes or notes in italics included in the Invitation to Bid, BDS, General Conditions of Contract, Special Conditions of Contract, Specifications, Drawings, and Bill of Quantities are not part of the text of the final document, although they contain instructions that the Procuring Entity should strictly follow.

- d. The cover should be modified as required to identify the Bidding Documents as to the names of the Project, Contract, and Procuring Entity, in addition to date of issue.
- e. Modifications for specific Procurement Project details should be provided in the Special Conditions of Contract as amendments to the Conditions of Contract. For easy completion, whenever reference has to be made to specific clauses in the Bid Data Sheet or Special Conditions of Contract, these terms shall be printed in bold typeface on Sections I (Instructions to Bidders) and III (General Conditions of Contract), respectively.
- f. For guidelines on the use of Bidding Forms and the procurement of Foreign-Assisted Projects, these will be covered by a separate issuance of the Government Procurement Policy Board.

# TABLE OF CONTENTS

Glossary of Terms, Abbreviations, and Acronyms .....	5
<b>SECTION I. INVITATION TO BID .....</b>	<b>8</b>
<b>SECTION II. INSTRUCTIONS TO BIDDERS .....</b>	<b>12</b>
1. Scope of Bid.....	13
2. Funding Information .....	13
3. Bidding Requirements.....	13
4. Corrupt, Fraudulent, Collusive, Coercive, and Obstructive Practices .....	13
5. Eligible Bidders.....	14
6. Origin of Associated Goods .....	14
7. Subcontracts .....	14
8. Pre-Bid Conference.....	14
9. Clarification and Amendment of Bidding Documents.....	15
10. Documents Comprising the Bid: Eligibility and Technical Components.....	15
11. Documents Comprising the Bid: Financial Component .....	15
12. Alternative Bids .....	16
13. Bid Prices .....	16
14. Bid and Payment Currencies.....	16
15. Bid Security.....	16
16. Sealing and Marking of Bids.....	16
17. Deadline for Submission of Bids .....	17
18. Opening and Preliminary Examination of Bids .....	17
19. Detailed Evaluation and Comparison of Bids .....	17
20. Post Qualification.....	18
21. Signing of the Contract .....	18
<b>SECTION III. BID DATA SHEET.....</b>	<b>19</b>
<b>SECTION IV. GENERAL CONDITIONS OF CONTRACT.....</b>	<b>26</b>
1. Scope of Contract.....	27
2. Sectional Completion of Works .....	27
3. Possession of Site.....	27
4. The Contractor’s Obligations.....	27

5.	Performance Security .....	28
6.	Site Investigation Reports .....	28
7.	Warranty.....	28
8.	Liability of the Contractor.....	28
9.	Termination for Other Causes.....	29
10.	Dayworks .....	29
11.	Program of Work.....	29
12.	Instructions, Inspections and Audits .....	29
13.	Advance Payment.....	29
14.	Progress Payments .....	30
15.	Operating and Maintenance Manual .....	30
<b>SECTION V. SPECIAL CONDITIONS OF CONTRACT .....</b>		<b>31</b>
<b>SECTION VI. SPECIFICATIONS .....</b>		<b>34</b>
<b>SECTION VII. DRAWINGS .....</b>		<b>59</b>
<b>SECTION VIII. BILL OF QUANTITIES .....</b>		<b>111</b>
<b>SECTION IX. CHECKLIST OF TECHNICAL AND FINANCIAL DOCUMENTS.....</b>		<b>114</b>
<b>BIDDING FORMS.....</b>		<b>115</b>
<b>ANNEXES .....</b>		<b>128</b>

# *Glossary of Terms, Abbreviations, and Acronyms*

**ABC** – Approved Budget for the Contract.

**ARCC** – Allowable Range of Contract Cost.

**BAC** – Bids and Awards Committee.

**Bid** – A signed offer or proposal to undertake a contract submitted by a bidder in response to and in consonance with the requirements of the bidding documents. Also referred to as *Proposal* and *Tender*. (2016 revised IRR, Section 5[c])

**Bidder** – Refers to a contractor, manufacturer, supplier, distributor and/or consultant who submits a bid in response to the requirements of the Bidding Documents. (2016 revised IRR, Section 5[d])

**Bidding Documents** – The documents issued by the Procuring Entity as the bases for bids, furnishing all information necessary for a prospective bidder to prepare a bid for the Goods, Infrastructure Projects, and/or Consulting Services required by the Procuring Entity. (2016 revised IRR, Section 5[e])

**BIR** – Bureau of Internal Revenue.

**BSP** – Bangko Sentral ng Pilipinas.

**CDA** – Cooperative Development Authority.

**Consulting Services** – Refer to services for Infrastructure Projects and other types of projects or activities of the GOP requiring adequate external technical and professional expertise that are beyond the capability and/or capacity of the GOP to undertake such as, but not limited to: (i) advisory and review services; (ii) pre-investment or feasibility studies; (iii) design; (iv) construction supervision; (v) management and related services; and (vi) other technical services or special studies. (2016 revised IRR, Section 5[i])

**Contract** – Refers to the agreement entered into between the Procuring Entity and the Supplier or Manufacturer or Distributor or Service Provider for procurement of Goods and Services; Contractor for Procurement of Infrastructure Projects; or Consultant or Consulting Firm for Procurement of Consulting Services; as the case may be, as recorded in the Contract Form signed by the parties, including all attachments and appendices thereto and all documents incorporated by reference therein.

**Contractor** – is a natural or juridical entity whose proposal was accepted by the Procuring Entity and to whom the Contract to execute the Work was awarded. Contractor as used in

these Bidding Documents may likewise refer to a supplier, distributor, manufacturer, or consultant.

**CPI** – Consumer Price Index.

**DOLE** – Department of Labor and Employment.

**DTI** – Department of Trade and Industry.

**Foreign-funded Procurement or Foreign-Assisted Project** –Refers to procurement whose funding source is from a foreign government, foreign or international financing institution as specified in the Treaty or International or Executive Agreement. (2016 revised IRR, Section 5[b]).

**GFI** – Government Financial Institution.

**GOCC** –Government-owned and/or –controlled corporation.

**Goods** – Refer to all items, supplies, materials and general support services, except Consulting Services and Infrastructure Projects, which may be needed in the transaction of public businesses or in the pursuit of any government undertaking, project or activity, whether in the nature of equipment, furniture, stationery, materials for construction, or personal property of any kind, including non-personal or contractual services such as the repair and maintenance of equipment and furniture, as well as trucking, hauling, janitorial, security, and related or analogous services, as well as procurement of materials and supplies provided by the Procuring Entity for such services. The term “related” or “analogous services” shall include, but is not limited to, lease or purchase of office space, media advertisements, health maintenance services, and other services essential to the operation of the Procuring Entity. (2016 revised IRR, Section 5[r])

**GOP** – Government of the Philippines.

**Infrastructure Projects** – Include the construction, improvement, rehabilitation, demolition, repair, restoration or maintenance of roads and bridges, railways, airports, seaports, communication facilities, civil works components of information technology projects, irrigation, flood control and drainage, water supply, sanitation, sewerage and solid waste management systems, shore protection, energy/power and electrification facilities, national buildings, school buildings, hospital buildings, and other related construction projects of the government. Also referred to as *civil works or works*. (2016 revised IRR, Section 5[u])

**LGUs** – Local Government Units.

**NFCC** – Net Financial Contracting Capacity.

**NGA** – National Government Agency.

**PCAB** – Philippine Contractors Accreditation Board.

**PhilGEPS** - Philippine Government Electronic Procurement System.

**Procurement Project** – refers to a specific or identified procurement covering goods, infrastructure project or consulting services. A Procurement Project shall be described, detailed, and scheduled in the Project Procurement Management Plan prepared by the agency which shall be consolidated in the procuring entity's Annual Procurement Plan. (GPPB Circular No. 06-2019 dated 17 July 2019)

**PSA** – Philippine Statistics Authority.

**SEC** – Securities and Exchange Commission.

**SLCC** – Single Largest Completed Contract.

**UN** – United Nations.



## ***Section I. Invitation to Bid***

### **Notes on the Invitation to Bid**

The Invitation to Bid (IB) provides information that enables potential Bidders to decide whether to participate in the procurement at hand. The IB shall be posted in accordance with Section 21.2 of the 2016 revised IRR of RA No. 9184.

Apart from the essential items listed in the Bidding Documents, the IB should also indicate the following:

- a. The date of availability of the Bidding Documents, which shall be from the time the IB is first advertised/posted until the deadline for the submission and receipt of bids;
- b. The place where the Bidding Documents may be acquired or the website where it may be downloaded;
- c. The deadline for the submission and receipt of bids; and
- d. Any important bid evaluation criteria.

The IB should be incorporated into the Bidding Documents. The information contained in the IB must conform to the Bidding Documents and in particular to the relevant information in the Bid Data Sheet.



Republic of the Philippines  
**Department of Education**  
REGION VII – central visayas  
**SCHOOLS DIVISION OF NEGROS ORIENTAL**

**Invitation to Bid**  
**for**  
**CY 2022 Quick Response Fund (QRF) New Construction of**  
**School Buildings for Schools Affected by Calamities, Epidemics,**  
**Crises, & Catastrophes - Lot 2 (Manjuyod Central Elementary**  
**School, Negros Oriental)**

1. The **Department of Education - Schools Division of Negros Oriental**, through its Bids and Awards Committee (BAC), with reference to a DepEd Memorandum dated 11 January 2023, intends to apply the sum of **Eleven Million Seven Hundred Sixty Six Thousand Three Hundred Ninety Nine and 62/100 Pesos (Php11,766,399.62)** being the Approved Budget for the Contract (ABC) to payments under the contract for **CY 2022 Quick Response Fund (QRF) New Construction of School Buildings for Schools Affected by Calamities, Epidemics, Crises, & Catastrophes - Lot 2 (Manjuyod Central Elementary School, Negros Oriental)** with project ID no.: ITB 2023-02-026. Bids received in excess of the ABC shall be automatically rejected at bid opening.
2. The **Department of Education - Schools Division of Negros Oriental** now invites bids for the above Procurement Project. Completion of the Works is required **Two Hundred Ten (210) Calendar Days**. Bidders should have completed a contract similar to the Project. The description of an eligible bidder is contained in the Bidding Documents, particularly, in Section II (Instructions to Bidders).
3. Bidding will be conducted through open competitive bidding procedures using non-discretionary “*pass/fail*” criterion as specified in the 2016 revised Implementing Rules and Regulations (IRR) of Republic Act (RA) No. 9184.
4. Interested bidders may obtain further information from the **Department of Education - Schools Division of Negros Oriental** and inspect the Bidding Documents at the address given below from **8:00 AM to 5:00 PM (Monday to Friday)**.
5. A complete set of Bidding Documents may be acquired by interested bidders on **February 23, 2023 and until the opening of bids** from given address below and upon payment of the applicable fee for the Bidding Documents, pursuant to the latest Guidelines issued by the GPPB, in the amount of **Twenty Five Thousand Pesos Only (Php25,000.00)**.

Interested bidders may pay the applicable fees in person or deposit their payment for the Bidding Document to our Development Bank of the Philippines (DBP) account, details as follows:

Account Name: DepEd, Division of Negros Oriental  
Account Number: 0-00160-740-1

The bidder must present its proof of payment for the fees in person or email its proof of payment to this email address: **negros.oriental@deped.gov.ph** before the specified date and time of the bid opening. Payments will be verified with the bank.

6. The **Department of Education - Schools Division of Negros Oriental** will hold a Pre-Bid Conference<sup>1</sup> on **10:00 A.M., March 3, 2023** at the 3<sup>rd</sup> Floor Conference Room, DepEd, Schools Division of Negros Oriental, Kagawasan Avenue, Capitol Area, Daro, Dumaguete City and/or through videoconferencing/webcasting via ZOOM link which shall be open to prospective bidders:

**<https://bit.ly/QRNewConPrebid>**



7. Bids must be duly received by the BAC Secretariat through manual submission at the office address as indicated below, on or before **10:00 A.M., March 15, 2023**. Late bids shall not be accepted.
8. All bids must be accompanied by a bid security in any of the acceptable forms and in the amount stated in **ITB** Clause 15.
9. Bid opening shall be on **10:00 A.M., March 15, 2023** at the 3<sup>rd</sup> Floor Conference Room, DepEd, Schools Division of Negros Oriental, Kagawasan Avenue, Capitol Area, Daro, Dumaguete City and/or through videoconferencing/webcasting via ZOOM link:

**<https://bit.ly/QRNewConBidOpening>**



Bids will be opened in the presence of the bidders' representatives who choose to attend the activity.

10. The **Department of Education - Schools Division of Negros Oriental** reserves the right to reject any and all bids, declare a failure of bidding, or not award the contract at any time prior to contract award in accordance with Sections 35.6 and 41 of the 2016 revised Implementing Rules and Regulations (IRR) of RA No. 9184, without thereby incurring any liability to the affected bidder or bidders.

---

<sup>1</sup> May be deleted in case the ABC is less than One Million Pesos (PhP1,000,000) where the Procuring Entity may not hold a pre-bid conference.

11. For further information, please refer to:

**MARCELO K. PALISPIS, JD EdD**  
BAC Chairperson, OIC - ASDS  
Schools Division of Negros Oriental  
Kagawasan Avenue, Capitol Area, Daro  
Dumaguete City, Negros Oriental 6200  
(035) 225 1623 / [www.depednegor.net](http://www.depednegor.net)

12. You may visit our official website: <https://www.depednegor.net/> and click on PROCUREMENT menu bar.

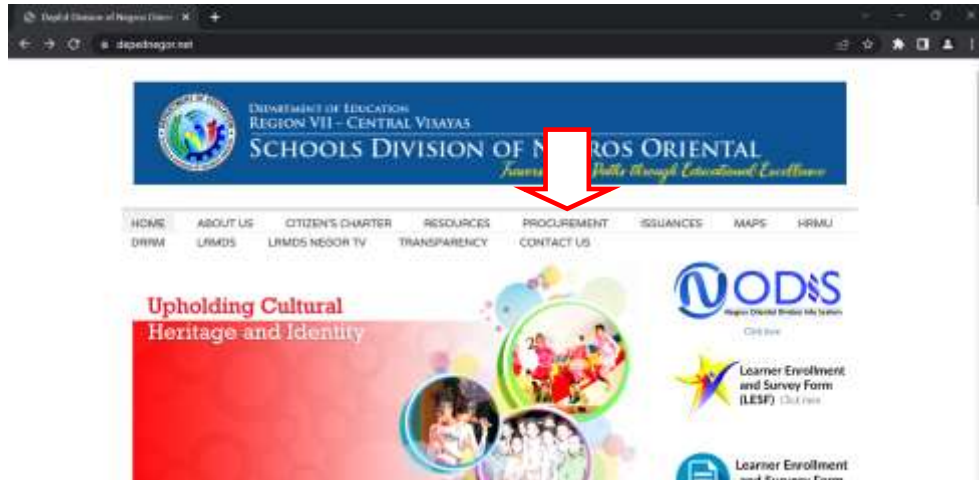

On the procurement page click on bid bulletin menu bar.

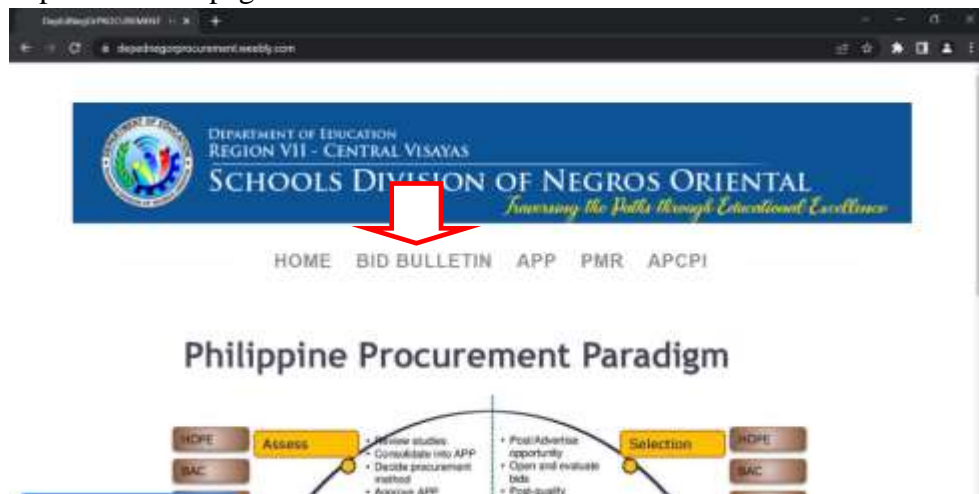

(Sgd.)

**MARCELO K. PALISPIS, JD EdD**  
OIC - Asst. Schools Division Superintendent  
Chairperson, Bids & Awards Committee

## ***Section II. Instructions to Bidders***

### **Notes on the Instructions to Bidders**

This Section on the Instruction to Bidders (ITB) provides the information necessary for bidders to prepare responsive bids, in accordance with the requirements of the Procuring Entity. It also provides information on bid submission, eligibility check, opening and evaluation of bids, post-qualification, and on the award of contract.

## 1. **Scope of Bid**

The Procuring Entity, **Department of Education - Schools Division of Negros Oriental** invites Bids for the **CY 2022 Quick Response Fund (QRF) New Construction of School Buildings for Schools Affected by Calamities, Epidemics, Crises, & Catastrophes - Lot 2 (Manjuyod Central Elementary School, Negros Oriental)** with Project Identification Number: **ITB 2023-02-026**.

The Procurement Project (referred to herein as “Project”) is for the construction of Works, as described in Section VI (Specifications).

## 2. **Funding Information**

2.1. The GOP through the source of funding as indicated below for Calendar Year 2022 in the amount of **Eleven Million Seven Hundred Sixty Six Thousand Three Hundred Ninety Nine and 62/100 Pesos (Php11,766,399.62)**.

2.2. The source of funding is NGA, the General Appropriations Act or Special Appropriations.

## 3. **Bidding Requirements**

The Bidding for the Project shall be governed by all the provisions of RA No. 9184 and its 2016 revised IRR, including its Generic Procurement Manual and associated policies, rules and regulations as the primary source thereof, while the herein clauses shall serve as the secondary source thereof.

Any amendments made to the IRR and other GPPB issuances shall be applicable only to the ongoing posting, advertisement, or invitation to bid by the BAC through the issuance of a supplemental or bid bulletin.

The Bidder, by the act of submitting its Bid, shall be deemed to have inspected the site, determined the general characteristics of the contracted Works and the conditions for this Project, such as (a) the location and the nature of the work; (b) climatic conditions; (c) transportation facilities; (d) nature and condition of the terrain, geological conditions at the site communication facilities, requirements, location and availability of construction aggregates and other materials, labor, water, electric power and access roads; and (e) other factors that may affect the cost, duration and execution or implementation of the contract, project, or work and examine all instructions, forms, terms, and project requirements in the Bidding Documents.

## 4. **Corrupt, Fraudulent, Collusive, Coercive, and Obstructive Practices**

The Procuring Entity, as well as the Bidders and Contractors, shall observe the highest standard of ethics during the procurement and execution of the contract. They

or through an agent shall not engage in corrupt, fraudulent, collusive, coercive, and obstructive practices defined under Annex “I” of the 2016 revised IRR of RA No. 9184 or other integrity violations in competing for the Project.

## **5. Eligible Bidders**

- 5.1. Only Bids of Bidders found to be legally, technically, and financially capable will be evaluated.
- 5.2. The Bidder must have an experience of having completed a Single Largest Completed Contract (SLCC) that is similar to this Project, equivalent to at least fifty percent (50%) of the ABC adjusted, if necessary, by the Bidder to current prices using the PSA’s CPI, except under conditions provided for in Section 23.4.2.4 of the 2016 revised IRR of RA No. 9184.

A contract is considered to be “similar” to the contract to be bid if it has the major categories of work stated in the **BDS**.

- 5.3. For Foreign-funded Procurement, the Procuring Entity and the foreign government/foreign or international financing institution may agree on another track record requirement, as specified in the Bidding Document prepared for this purpose.
- 5.4. The Bidders shall comply with the eligibility criteria under Section 23.4.2 of the 2016 IRR of RA No. 9184.

## **6. Origin of Associated Goods**

There is no restriction on the origin of Goods other than those prohibited by a decision of the UN Security Council taken under Chapter VII of the Charter of the UN.

## **7. Subcontracts**

- 7.1. The Bidder may subcontract portions of the Project to the extent allowed by the Procuring Entity as stated herein, but in no case more than fifty percent (50%) of the Project.

The Procuring Entity has prescribed that **Subcontracting is not allowed**.

## **8. Pre-Bid Conference**

The Procuring Entity will hold a pre-bid conference for this Project on the specified date and time and either at its physical address and/or through videoconferencing / webcasting as indicated in paragraph 6 of the **IB**.

## **9. Clarification and Amendment of Bidding Documents**

Prospective bidders may request for clarification on and/or interpretation of any part of the Bidding Documents. Such requests must be in writing and received by the Procuring Entity, either at its given address or through electronic mail indicated in the **IB**, at least ten (10) calendar days before the deadline set for the submission and receipt of Bids.

## **10. Documents Comprising the Bid: Eligibility and Technical Components**

- 10.1. The first envelope shall contain the eligibility and technical documents of the Bid as specified in **Section IX. Checklist of Technical and Financial Documents**.
- 10.2. If the eligibility requirements or statements, the bids, and all other documents for submission to the BAC are in foreign language other than English, it must be accompanied by a translation in English, which shall be authenticated by the appropriate Philippine foreign service establishment, post, or the equivalent office having jurisdiction over the foreign bidder's affairs in the Philippines. For Contracting Parties to the Apostille Convention, only the translated documents shall be authenticated through an apostille pursuant to GPPB Resolution No. 13-2019 dated 23 May 2019. The English translation shall govern, for purposes of interpretation of the bid.
- 10.3. A valid PCAB License is required, and in case of joint ventures, a valid special PCAB License, and registration for the type and cost of the contract for this Project. Any additional type of Contractor license or permit shall be indicated in the **BDS**.
- 10.4. A List of Contractor's key personnel (e.g., Project Manager, Project Engineers, Materials Engineers, and Foremen) assigned to the contract to be bid, with their complete qualification and experience data shall be provided. These key personnel must meet the required minimum years of experience set in the **BDS**.
- 10.5. A List of Contractor's major equipment units, which are owned, leased, and/or under purchase agreements, supported by proof of ownership, certification of availability of equipment from the equipment lessor/vendor for the duration of the project, as the case may be, must meet the minimum requirements for the contract set in the **BDS**.

## **11. Documents Comprising the Bid: Financial Component**

- 11.1. The second bid envelope shall contain the financial documents for the Bid as specified in **Section IX. Checklist of Technical and Financial Documents**.



- 11.2. Any bid exceeding the ABC indicated in paragraph 1 of the **IB** shall not be accepted.
- 11.3. For Foreign-funded procurement, a ceiling may be applied to bid prices provided the conditions are met under Section 31.2 of the 2016 revised IRR of RA No. 9184.

## **12. Alternative Bids**

Bidders shall submit offers that comply with the requirements of the Bidding Documents, including the basic technical design as indicated in the drawings and specifications. Unless there is a value engineering clause in the **BDS**, alternative Bids shall not be accepted.

## **13. Bid Prices**

All bid prices for the given scope of work in the Project as awarded shall be considered as fixed prices, and therefore not subject to price escalation during contract implementation, except under extraordinary circumstances as determined by the NEDA and approved by the GPPB pursuant to the revised Guidelines for Contract Price Escalation guidelines.

## **14. Bid and Payment Currencies**

- 14.1. Bid prices may be quoted in the local currency or tradeable currency accepted by the BSP at the discretion of the Bidder. However, for purposes of bid evaluation. Bids denominated in foreign currencies shall be converted to Philippines currency based on the exchange rate as published in the BSP reference rate bulletin on the day of the bid opening.
- 14.2. Payment of the contract price shall be made in Philippine Pesos.

## **15. Bid Security**

- 15.1. The Bidder shall submit a Bid Securing Declaration or any form of Bid Security in the amount indicated in the **BDS**, which shall be not less than the percentage of the ABC in accordance with the schedule in the **BDS**.
- 15.2. The Bid and bid security shall be valid One Hundred Twenty (120) Calendar Days from the opening of bids. Any bid not accompanied by an acceptable bid security shall be rejected by the Procuring Entity as non-responsive.

## **16. Sealing and Marking of Bids**

Each Bidder shall submit one copy of the first and second components of its Bid.

The Procuring Entity may request additional hard copies and/or electronic copies of the Bid. However, failure of the Bidders to comply with the said request shall not be a ground for disqualification.

If the Procuring Entity allows the submission of bids through online submission to the given website or any other electronic means, the Bidder shall submit an electronic copy of its Bid, which must be digitally signed. An electronic copy that cannot be opened or is corrupted shall be considered non-responsive and, thus, automatically disqualified.

## **17. Deadline for Submission of Bids**

The Bidders shall submit on the specified date and time and either at its physical address or through online submission as indicated in paragraph 7 of the **IB**.

## **18. Opening and Preliminary Examination of Bids**

18.1. The BAC shall open the Bids in public at the time, on the date, and at the place specified in paragraph 9 of the **IB**. The Bidders' representatives who are present shall sign a register evidencing their attendance. In case videoconferencing, webcasting or other similar technologies will be used, attendance of participants shall likewise be recorded by the BAC Secretariat.

In case the Bids cannot be opened as scheduled due to justifiable reasons, the rescheduling requirements under Section 29 of the 2016 revised IRR of RA No. 9184 shall prevail.

18.2. The preliminary examination of Bids shall be governed by Section 30 of the 2016 revised IRR of RA No. 9184.

## **19. Detailed Evaluation and Comparison of Bids**

19.1. The Procuring Entity's BAC shall immediately conduct a detailed evaluation of all Bids rated "*passed*" using non-discretionary pass/fail criteria. The BAC shall consider the conditions in the evaluation of Bids under Section 32.2 of 2016 revised IRR of RA No. 9184.

19.2. If the Project allows partial bids, all Bids and combinations of Bids as indicated in the **BDS** shall be received by the same deadline and opened and evaluated simultaneously so as to determine the Bid or combination of Bids offering the lowest calculated cost to the Procuring Entity. Bid Security as required by **ITB** Clause 15 shall be submitted for each contract (lot) separately.

19.3. In all cases, the NFCC computation pursuant to Section 23.4.2.6 of the 2016 revised IRR of RA No. 9184 must be sufficient for the total of the ABCs for all the lots participated in by the prospective Bidder.

## **20. Post Qualification**

Within a non-extendible period of five (5) calendar days from receipt by the Bidder of the notice from the BAC that it submitted the Lowest Calculated Bid, the Bidder shall submit its latest income and business tax returns filed and paid through the BIR Electronic Filing and Payment System (eFPS), and other appropriate licenses and permits required by law and stated in the **BDS**.

## **21. Signing of the Contract**

The documents required in Section 37.2 of the 2016 revised IRR of RA No. 9184 shall form part of the Contract. Additional Contract documents are indicated in the **BDS**.

## ***Section III. Bid Data Sheet***

### **Notes on the Bid Data Sheet (BDS)**

The Bid Data Sheet (BDS) consists of provisions that supplement, amend, or specify in detail, information, or requirements included in the ITB found in Section II, which are specific to each procurement.

This Section is intended to assist the Procuring Entity in providing the specific information in relation to corresponding clauses in the ITB and has to be prepared for each specific procurement.

The Procuring Entity should specify in the BDS information and requirements specific to the circumstances of the Procuring Entity, the processing of the procurement, and the bid evaluation criteria that will apply to the Bids. In preparing the BDS, the following aspects should be checked:

- a. Information that specifies and complements provisions of the ITB must be incorporated.
- b. Amendments and/or supplements, if any, to provisions of the ITB as necessitated by the circumstances of the specific procurement, must also be incorporated.

# Bid Data Sheet

ITB Clause	
3	<p>The Department of Education, Schools Division of Negros Oriental requires that interested bidder/s shall secure the Certificate of Site Inspection signed by the school head or its representative and the duly notarized Affidavit of Site Inspection. Both documents shall be included in the Technical Component Envelope. <i>(Items (j) and (k) of Section IX. Checklist of Technical and Financial Document)</i></p> <p>Standard forms can be found in ANNEX A and can also be acquired upon purchase of the bid document.</p>
5.2	<p>For this purpose, contracts similar to the Project refer to contracts which have the same major categories of work, which shall be but not limited to:</p> <ol style="list-style-type: none"> <li>1. Concreting Works (3000 psi)</li> <li>2. Masonry Works</li> <li>3. Doors and Windows</li> <li>4. Steel Works</li> <li>5. Rebar Works</li> <li>6. Earthworks</li> <li>7. Roofing Works</li> <li>8. Ceiling and Carpentry Works</li> <li>9. Electrical Works</li> <li>10. Plumbing Works with Rain Water Collector</li> <li>11. Formworks</li> <li>12. Painting Works</li> <li>13. Tile Works</li> <li>14. Sanitary Works</li> <li>15. Waterproofing Works</li> </ol>
7.1	Subcontracting is not allowed.
10.1	<p>Bidder's Statement of all its ongoing government and private contracts, including contracts awarded but not yet started; and Bidder's Single Largest Completed Contract (SLCC) should be supported by, but not limited to: (a) Notice of Award; (b) Notice to Proceed; or (c) Project Owner's Certificate of Final Acceptance issued by the owner other than the contractor.</p> <p>Furthermore, bidder/s shall also provide an electronic "soft" copy, in MS Excel file format of the above-mentioned Bidder's statement of all ongoing projects to aid post-qualification evaluation / verification. This soft copy shall be stored either on a compact disc (CD) or on a flash drive (USB) and must be included in the Technical Component Envelope.</p> <p><i>(Reference to Clause 16 of Section III. Instruction to Bidders and also to items (b))</i></p>

	<i>and (c) of Section IX. Checklist of Technical and Financial Documents.)</i>																						
10.3	No further instructions.																						
10.4	<p>The key personnel must meet the required minimum years of experience set below:</p> <table border="1"> <thead> <tr> <th><b>KEY PERSONNEL</b></th> <th><b>Number of Years of Relevant Experience</b></th> </tr> </thead> <tbody> <tr> <td>1. Project Engineer</td> <td>At least 1 year experience</td> </tr> <tr> <td>2. Materials Engineer</td> <td>At least 1 year experience</td> </tr> <tr> <td>3. General Foreman</td> <td>At least 1 year experience</td> </tr> <tr> <td>4. Welder</td> <td>At least 1 year experience</td> </tr> <tr> <td>5. Carpenter</td> <td>At least 1 year experience</td> </tr> <tr> <td>6. Mason</td> <td>At least 1 year experience</td> </tr> <tr> <td>7. Painter</td> <td>At least 1 year experience</td> </tr> <tr> <td>8. Electrician</td> <td>At least 1 year experience</td> </tr> <tr> <td>9. Plumber</td> <td>At least 1 year experience</td> </tr> <tr> <td>10. Helper</td> <td>At least 1 year experience</td> </tr> </tbody> </table>	<b>KEY PERSONNEL</b>	<b>Number of Years of Relevant Experience</b>	1. Project Engineer	At least 1 year experience	2. Materials Engineer	At least 1 year experience	3. General Foreman	At least 1 year experience	4. Welder	At least 1 year experience	5. Carpenter	At least 1 year experience	6. Mason	At least 1 year experience	7. Painter	At least 1 year experience	8. Electrician	At least 1 year experience	9. Plumber	At least 1 year experience	10. Helper	At least 1 year experience
<b>KEY PERSONNEL</b>	<b>Number of Years of Relevant Experience</b>																						
1. Project Engineer	At least 1 year experience																						
2. Materials Engineer	At least 1 year experience																						
3. General Foreman	At least 1 year experience																						
4. Welder	At least 1 year experience																						
5. Carpenter	At least 1 year experience																						
6. Mason	At least 1 year experience																						
7. Painter	At least 1 year experience																						
8. Electrician	At least 1 year experience																						
9. Plumber	At least 1 year experience																						
10. Helper	At least 1 year experience																						
10.5	<p>The minimum major equipment requirements are the following:</p> <ol style="list-style-type: none"> <li>1. Hand Tools</li> <li>2. One Bagger Cement Mixer</li> <li>3. Welding Machine</li> <li>4. Steel Bar Cutter</li> </ol>																						
11.1	<p>Interested bidder/s are provider with an electronic “soft” copy, <u>MS Excel file format</u> of the following, upon purchase of this bidding document:</p> <ol style="list-style-type: none"> <li>1. Blank Program of Works – Bill of Quantities</li> <li>2. Blank Program of Works – Detailed Cost Estimates</li> </ol> <p>The above-mentioned blank Program of Works - Bill of Quantities and Detailed Cost Estimates must be filled-in and shall be stored (<i>with the same MS Excel file format</i>) either on a compact disc (CD) or on a flash drive (USB). (<i>with reference also to GCC Clause 11.1 of Section V. Special Condition of the Contract</i>)</p> <p>Bidder/s shall also prepare the <u>summary sheet</u> indicating the unit prices of construction materials, labor rates, and equipment rentals used in coming up with the Bid and must be the same unit prices of construction materials, labor rates and equipment rentals reflected on their Program of Works – Detailed Cost Estimates.</p> <p>Any discrepancies on unit prices of construction materials, labor rates, and equipment rentals, etc. between Bidder’s Summary Sheet and Program of Works – Detailed Cost Estimates are grounds for disqualification. No Summary Sheet is also grounds for disqualification.</p>																						

	<i>(Reference to Clause 16 of Section III. Instruction to Bidders and also to Items (m) and (n) respectively of Section IX. Checklist of Technical and Financial Documents)</i>												
12	No further instructions												
15.1	<p>The bidder shall submit a Bid Securing Declaration, or any form of Bid Security, in an amount not less than the required percentage of the ABC in accordance with the following schedule:</p> <table border="1"> <thead> <tr> <th><b>Form of Bid Security</b></th> <th><b>Amount of Bid Security (Not less than the required percentage of the ABC)</b></th> </tr> </thead> <tbody> <tr> <td>a. Cash or cashier's/manager's check issued by a Universal or Commercial Bank.</td> <td><b>Two percent (2%)</b></td> </tr> <tr> <td>b. Bank draft/guarantee or irrevocable letter of credit issued by a Universal or Commercial Bank: Provided, however, That it shall be confirmed or authenticated by a Universal or Commercial Bank, if issued by a foreign bank</td> <td><b>Two percent (2%)</b></td> </tr> <tr> <td>c. Surety bond callable upon demand issued by a surety or insurance company duly certified by the Insurance Commission as authorized to issue such security.</td> <td><b>Five percent (5%)</b></td> </tr> <tr> <td>d. Any combination of items (a) to (c) above.</td> <td><b>Proportionate to share of form with respect to total amount of security</b></td> </tr> <tr> <td>e. Bid Securing Declaration</td> <td><b>No percentage required</b></td> </tr> </tbody> </table>	<b>Form of Bid Security</b>	<b>Amount of Bid Security (Not less than the required percentage of the ABC)</b>	a. Cash or cashier's/manager's check issued by a Universal or Commercial Bank.	<b>Two percent (2%)</b>	b. Bank draft/guarantee or irrevocable letter of credit issued by a Universal or Commercial Bank: Provided, however, That it shall be confirmed or authenticated by a Universal or Commercial Bank, if issued by a foreign bank	<b>Two percent (2%)</b>	c. Surety bond callable upon demand issued by a surety or insurance company duly certified by the Insurance Commission as authorized to issue such security.	<b>Five percent (5%)</b>	d. Any combination of items (a) to (c) above.	<b>Proportionate to share of form with respect to total amount of security</b>	e. Bid Securing Declaration	<b>No percentage required</b>
<b>Form of Bid Security</b>	<b>Amount of Bid Security (Not less than the required percentage of the ABC)</b>												
a. Cash or cashier's/manager's check issued by a Universal or Commercial Bank.	<b>Two percent (2%)</b>												
b. Bank draft/guarantee or irrevocable letter of credit issued by a Universal or Commercial Bank: Provided, however, That it shall be confirmed or authenticated by a Universal or Commercial Bank, if issued by a foreign bank	<b>Two percent (2%)</b>												
c. Surety bond callable upon demand issued by a surety or insurance company duly certified by the Insurance Commission as authorized to issue such security.	<b>Five percent (5%)</b>												
d. Any combination of items (a) to (c) above.	<b>Proportionate to share of form with respect to total amount of security</b>												
e. Bid Securing Declaration	<b>No percentage required</b>												
16	<p>Bidders shall enclose their original eligibility and technical documents described in ITB Clause 10, in one sealed envelope marked "ORIGINAL - TECHNICAL COMPONENT," and the original of their financial component in another sealed envelope marked "ORIGINAL - FINANCIAL COMPONENT," sealing them all in an outer envelope marked "ORIGINAL BID."</p> <p>Bidders are required to provide only a single copy of the Technical Component and the Financial Component envelopes shall be similarly sealed duly marking the inner envelopes as "COPY NO. 1 - TECHNICAL COMPONENT" and "COPY NO. 1 – FINANCIAL COMPONENT" respectively. These envelopes containing the original and the copy, including CD/USB flash drive shall then</p>												

	<p>be enclosed in one single envelope. .</p> <p>The CD or USB Flash drive shall contain an electronic copy of the following:</p> <ol style="list-style-type: none"> <li>1. Bidder’s Statement of All On-going Projects in MS Excel File Format;</li> <li>2. Bid Prices in the Bill of Quantities (Program of Works – Bill of Quantities) in MS Excel File Format;</li> <li>3. Accomplished Detailed Estimates Form (Program of Works – Detailed Cost Estimates) in Excel File Format, including the summary sheet.</li> </ol> <p>The original and the copy 1 of the bid shall be typed or written in ink and shall be signed by the Bidder or its duly authorized representative/s.</p> <p>All envelopes shall:</p> <ol style="list-style-type: none"> <li>(a) contain the name of the contract to be bid <b>in capital letters</b>;</li> <li>(b) bear the name and address of the Bidder <b>in capital letters</b>;</li> <li>(c) be addressed to the Procuring Entity’s Bids and Awards Committee BAC, as indicated in paragraph 11 of the IB.</li> <li>(d) bear the specific identification of this bidding process indicated in the ITB Clause 1 and paragraph 1 &amp; 2 of the IB; and</li> <li>(e) bear a warning “DO NOT OPEN BEFORE...” the date and time for the opening of bids, in accordance with ITB Clause 17 and paragraph 7 of the IB.</li> </ol> <p>Unsealed or unmarked bid envelopes shall be rejected. However, bid envelopes that are not properly sealed and marked, as required in the Bidding Documents, shall be accepted, provided that the bidder or its duly authorized representative shall acknowledge such condition of the bid as submitted. The BAC shall assume no responsibility for the misplacement of the contents of the improperly sealed or marked bid, or for its premature opening. <i>(Section 25.9 of the Revised 2016 IRR of RA 9184, 8th Edition)</i></p> <p>An illustration for marking and sealing of Technical and Financial Envelopes can be found in ANNEX C.</p>
19.2	No partial bid is allowed.
20	<p>The BAC shall determine to its satisfaction whether the Bidder that is evaluated as having submitted the Lowest Calculated Bid complies with and is responsive to all the requirements and conditions specified in <b>ITB</b> Clauses 5, 10, and 11.</p> <p>List of Licenses and permits relevant to the Project and the corresponding law or corresponding LGUs that may be required but not limited to:</p> <ol style="list-style-type: none"> <li>1. Building Permit</li> </ol>



	<p>2. Fire Safety Inspection Certificate 3. Electrical Permit, etc.</p>
<p>21</p>	<p>Additional contract documents relevant to the Project that are required by this Procuring Entity, among other documents, are the following:</p> <ol style="list-style-type: none"> <li>a. construction schedule and S-curve,</li> <li>b. manpower schedule,</li> <li>c. construction methods,</li> <li>d. equipment utilization schedule,</li> <li>e. construction safety and health program approved by the DOLE,</li> <li>f. and other acceptable tools of project scheduling.</li> </ol> <p>Furthermore, all Department of Education implemented infrastructure projects are required to be covered by Contractor's All Risk Insurance (CARI) as per memorandum, OUA MEMO 00-0121-081. <i>(Please see ANNEX C)</i></p> <p>The following are insurance coverage clauses for this infrastructure project: <i>(adopted from the Philippine Bidding Document (PBD) 5<sup>th</sup> Edition)</i></p> <ol style="list-style-type: none"> <li>a. The contractor shall under his name and at his own expense, obtain and maintain, for the duration of this Contract, the Contractor's All Risk Insurance (CARI);</li> <li>b. The contractor shall provide evidence to the Procuring Entity's Representative that the insurances required under this Contract have been effected and shall, within a reasonable time, provide copies of the insurance policies to the Procuring Entity's Representative. Such evidence and such policies shall be provided to the Procuring Entity's through the Procuring Entity's Representative. The Contractor shall notify the insurers of changes in the nature, extent, or program for the execution of the Works and ensure the adequacy of the insurances at all times in accordance with the terms of this Contract and shall produce to the Procuring Entity's Representative the insurance policies in force including the receipts for payment of the current premiums;</li> <li>c. The above insurance policies shall be obtained from any reputable insurance company approved by the Procuring Entity's Representative;</li> <li>d. If the Contractor fails to obtain and keep in force the insurances referred to herein or any other insurance which he may be required to obtain under the terms of this Contract, the Procuring Entity may obtain and keep in force any such insurances and pay such premiums as may be necessary for the purpose. From time to time, the Procuring Entity may deduct the amount it shall pay for said premiums including twenty-five percent (25%) therein from any monies due, or which may become due, to the Contractor, without prejudice to the Procuring Entity exercising its right to</li> </ol>

impose other sanctions against the Contractor pursuant to the provisions of this Contract;

- e. In the event the Contractor fails to observe the above safeguards, the Procuring Entity may, at the Contractor's expense, take whatever measure is deemed necessary for its protection and that of the Contractor's personnel and third parties, and/or order the interruption of dangerous Works. In addition, the Procuring Entity may refuse to make the payments under GCC Clause 40 until the Contractor complies with this Clause;
- f. The Contractor shall immediately replace the insurance policy obtained as required in this Contract, without need of the Procuring Entity's demand, with a new policy issued by a new insurance company acceptable to the Procuring Entity for any of the following grounds:
  - (a) The issuer of the insurance policy to be replaced has:
    - (i) become bankrupt;
    - (ii) been placed under receivership or under a management committee;
    - (iii) been sued for suspension of payment; or
    - (iv) been suspended by the Insurance Commission and its license to engage in business or its authority to issue insurance policies cancelled; or
    - (v) Where reasonable grounds exist that the insurer may not be able, fully and promptly, to fulfill its obligation under the insurance policy.

## ***Section IV. General Conditions of Contract***

### **Notes on the General Conditions of Contract**

The General Conditions of Contract (GCC) in this Section, read in conjunction with the Special Conditions of Contract in Section V and other documents listed therein, should be a complete document expressing all the rights and obligations of the parties.

Matters governing performance of the Contractor, payments under the contract, or matters affecting the risks, rights, and obligations of the parties under the contract are included in the GCC and Special Conditions of Contract.

Any complementary information, which may be needed, shall be introduced only through the Special Conditions of Contract.

## 1. **Scope of Contract**

This Contract shall include all such items, although not specifically mentioned, that can be reasonably inferred as being required for its completion as if such items were expressly mentioned herein. All the provisions of RA No. 9184 and its 2016 revised IRR, including the Generic Procurement Manual, and associated issuances, constitute the primary source for the terms and conditions of the Contract, and thus, applicable in contract implementation. Herein clauses shall serve as the secondary source for the terms and conditions of the Contract.

This is without prejudice to Sections 74.1 and 74.2 of the 2016 revised IRR of RA No. 9184 allowing the GPPB to amend the IRR, which shall be applied to all procurement activities, the advertisement, posting, or invitation of which were issued after the effectivity of the said amendment.

## 2. **Sectional Completion of Works**

If sectional completion is specified in the **Special Conditions of Contract (SCC)**, references in the Conditions of Contract to the Works, the Completion Date, and the Intended Completion Date shall apply to any Section of the Works (other than references to the Completion Date and Intended Completion Date for the whole of the Works).

## 3. **Possession of Site**

3.1 The Procuring Entity shall give possession of all or parts of the Site to the Contractor based on the schedule of delivery indicated in the **SCC**, which corresponds to the execution of the Works. If the Contractor suffers delay or incurs cost from failure on the part of the Procuring Entity to give possession in accordance with the terms of this clause, the Procuring Entity's Representative shall give the Contractor a Contract Time Extension and certify such sum as fair to cover the cost incurred, which sum shall be paid by Procuring Entity.

3.2 If possession of a portion is not given by the above date, the Procuring Entity will be deemed to have delayed the start of the relevant activities. The resulting adjustments in contract time to address such delay may be addressed through contract extension provided under Annex "E" of the 2016 revised IRR of RA No. 9184.

## 4. **The Contractor's Obligations**

The Contractor shall employ the key personnel named in the Schedule of Key Personnel indicating their designation, in accordance with **ITB** Clause 10.3 and specified in the **BDS**, to carry out the supervision of the Works.

The Procuring Entity will approve any proposed replacement of key personnel only if their relevant qualifications and abilities are equal to or better than those of the personnel listed in the Schedule.

## **5. Performance Security**

5.1. Within ten (10) calendar days from receipt of the Notice of Award from the Procuring Entity but in no case later than the signing of the contract by both parties, the successful Bidder shall furnish the performance security in any of the forms prescribed in Section 39 of the 2016 revised IRR.

5.2. The Contractor, by entering into the Contract with the Procuring Entity, acknowledges the right of the Procuring Entity to institute action pursuant to RA No. 3688 against any subcontractor be they an individual, firm, partnership, corporation, or association supplying the Contractor with labor, materials and/or equipment for the performance of this Contract.

## **6. Site Investigation Reports**

The Contractor, in preparing the Bid, shall rely on any Site Investigation Reports referred to in the SCC supplemented by any information obtained by the Contractor.

## **7. Warranty**

7.1. In case the Contractor fails to undertake the repair works under Section 62.2.2 of the 2016 revised IRR, the Procuring Entity shall forfeit its performance security, subject its property(ies) to attachment or garnishment proceedings, and perpetually disqualify it from participating in any public bidding. All payables of the GOP in his favor shall be offset to recover the costs.

7.2. The warranty against Structural Defects/Failures, except that occasioned-on force majeure, shall cover the period from the date of issuance of the Certificate of Final Acceptance by the Procuring Entity. Specific duration of the warranty is found in the SCC.

## **8. Liability of the Contractor**

Subject to additional provisions, if any, set forth in the SCC, the Contractor's liability under this Contract shall be as provided by the laws of the Republic of the Philippines.

If the Contractor is a joint venture, all partners to the joint venture shall be jointly and severally liable to the Procuring Entity.

## **9. Termination for Other Causes**

Contract termination shall be initiated in case it is determined *prima facie* by the Procuring Entity that the Contractor has engaged, before, or during the implementation of the contract, in unlawful deeds and behaviors relative to contract acquisition and implementation, such as, but not limited to corrupt, fraudulent, collusive, coercive, and obstructive practices as stated in **ITB** Clause 4.

## **10. Dayworks**

Subject to the guidelines on Variation Order in Annex “E” of the 2016 revised IRR of RA No. 9184, and if applicable as indicated in the **SCC**, the Dayworks rates in the Contractor’s Bid shall be used for small additional amounts of work only when the Procuring Entity’s Representative has given written instructions in advance for additional work to be paid for in that way.

## **11. Program of Work**

11.1. The Contractor shall submit to the Procuring Entity’s Representative for approval the said Program of Work showing the general methods, arrangements, order, and timing for all the activities in the Works. The submissions of the Program of Work are indicated in the **SCC**.

11.2. The Contractor shall submit to the Procuring Entity’s Representative for approval an updated Program of Work at intervals no longer than the period stated in the **SCC**. If the Contractor does not submit an updated Program of Work within this period, the Procuring Entity’s Representative may withhold the amount stated in the **SCC** from the next payment certificate and continue to withhold this amount until the next payment after the date on which the overdue Program of Work has been submitted.

## **12. Instructions, Inspections and Audits**

The Contractor shall permit the GOP or the Procuring Entity to inspect the Contractor’s accounts and records relating to the performance of the Contractor and to have them audited by auditors of the GOP or the Procuring Entity, as may be required.

## **13. Advance Payment**

The Procuring Entity shall, upon a written request of the Contractor which shall be submitted as a Contract document, make an advance payment to the Contractor in an amount not exceeding fifteen percent (15%) of the total contract price, to be made in lump sum, or at the most two installments according to a schedule specified in the

**SCC**, subject to the requirements in Annex “E” of the 2016 revised IRR of RA No. 9184.

#### **14. Progress Payments**

The Contractor may submit a request for payment for Work accomplished. Such requests for payment shall be verified and certified by the Procuring Entity’s Representative/Project Engineer. Except as otherwise stipulated in the **SCC**, materials and equipment delivered on the site but not completely put in place shall not be included for payment.

#### **15. Operating and Maintenance Manual**

- 15.1. If required, the Contractor will provide “as built” Drawings and/or operating and maintenance manuals as specified in the **SCC**.
- 15.2. If the Contractor does not provide the Drawings and/or manuals by the dates stated above, or they do not receive the Procuring Entity’s Representative’s approval, the Procuring Entity’s Representative may withhold the amount stated in the **SCC** from payments due to the Contractor.

## ***Section V. Special Conditions of Contract***

### **Notes on the Special Conditions of Contract**

Similar to the BDS, the clauses in this Section are intended to assist the Procuring Entity in providing contract-specific information in relation to corresponding clauses in the GCC found in Section IV.

The Special Conditions of Contract (SCC) complement the GCC, specifying contractual requirements linked to the special circumstances of the Procuring Entity, the Procuring Entity's country, the sector, and the Works procured. In preparing this Section, the following aspects should be checked:

- a. Information that complements provisions of the GCC must be incorporated.
- b. Amendments and/or supplements to provisions of the GCC as necessitated by the circumstances of the specific purchase, must also be incorporated.

However, no special condition which defeats or negates the general intent and purpose of the provisions of the GCC should be incorporated herein.



# Special Conditions of Contract

GCC Clause	
2	No further instructions.
4.1	No further instructions.
6	No further instructions.
7.2	In case of permanent structures, such as buildings of types 4 and 5 as classified under the National Building Code of the Philippines and other structures made of steel, iron, or concrete which comply with relevant structural codes (e.g., DPWH Standard Specifications), such as, but not limited to, steel/concrete bridges, flyovers, aircraft movement areas, ports, dams, tunnels, filtration and treatment plants, sewerage systems, power plants, transmission and communication towers, railway system, and other similar permanent structures: Fifteen (15) years.
10	No dayworks are applicable to the contract.
11.1	<p><i>The Contractor shall submit the Program of Work to the Procuring Entity's Representative within [insert number] days of delivery of the Notice of Award.</i></p> <p>Blank Program of Works - Bill of Quantities and Detailed Cost Estimates for each school / item are provided herewith under Section VI, Specifications. To ensure completeness of the bid, any alterations or modifications made by a prospective bidder on: Item Description; Unit of Measure (UNIT); and Quantity (QTY) shall automatically disqualify them.</p> <p>Bidder/s shall only fill-in their Unit Cost (Material &amp; Labor); Total Cost (Material &amp; Labor); and Grand Total.</p> <p>An electronic "soft" copy of the above-mentioned Blank Program of Works - Bill of Quantities and Detailed Cost Estimates for each school / item are provided for prospective bidder/s upon purchase of this bidding document. This is to aide bidders in its preparation of bid proposals and to facilitate bid evaluation.</p> <p><i>(Reference also to Section 32.2.1(a) of the 2016 Revised Implementing Rules and Regulation of RA 9184)</i></p>
11.2	<i>The amount to be withheld for late submission of an updated Program of Work is [insert amount].</i>
13	<i>The amount of the advance payment is 15% of the total contract price and schedule of payment.</i>

14	Materials and equipment delivered on the site but not completely put in place shall not be included for payment.
15.1	<p><i>The date by which operating and maintenance manuals are required is [date].</i></p> <p><i>The date by which “as built” drawings are required is [date].</i></p>
15.2	<p><i>The amount to be withheld for failing to produce “as built” drawings and/or operating and maintenance manuals by the date required is [amount in local currency].</i></p>

## *Section VI. Specifications*

### **Notes on Specifications**

A set of precise and clear specifications is a prerequisite for Bidders to respond realistically and competitively to the requirements of the Procuring Entity without qualifying or conditioning their Bids. In the context of international competitive bidding, the specifications must be drafted to permit the widest possible competition and, at the same time, present a clear statement of the required standards of workmanship, materials, and performance of the goods and services to be procured. Only if this is done will the objectives of economy, efficiency, and fairness in procurement be realized, responsiveness of Bids be ensured, and the subsequent task of bid evaluation facilitated. The specifications should require that all goods and materials to be incorporated in the Works be new, unused, of the most recent or current models, and incorporate all recent improvements in design and materials unless provided otherwise in the Contract.

Samples of specifications from previous similar projects are useful in this respect. The use of metric units is mandatory. Most specifications are normally written specially by the Procuring Entity or its representative to suit the Works at hand. There is no standard set of Specifications for universal application in all sectors in all regions, but there are established principles and practices, which are reflected in these PBDs.

There are considerable advantages in standardizing General Specifications for repetitive Works in recognized public sectors, such as highways, ports, railways, urban housing, irrigation, and water supply, in the same country or region where similar conditions prevail. The General Specifications should cover all classes of workmanship, materials, and equipment commonly involved in construction, although not necessarily to be used in a particular Works Contract. Deletions or addenda should then adapt the General Specifications to the particular Works.

Care must be taken in drafting specifications to ensure that they are not restrictive. In the specification of standards for goods, materials, and workmanship, recognized international standards should be used as much as possible. Where other particular standards are used, whether national standards or other standards, the specifications should state that goods, materials, and workmanship that meet other authoritative standards, and which ensure substantially equal or higher quality than the standards mentioned, will also be acceptable. The following clause may be inserted in the SCC.

#### **Sample Clause: Equivalency of Standards and Codes**

Wherever reference is made in the Contract to specific standards and codes to be met by the goods and materials to be furnished, and work performed or tested, the provisions of the latest current edition or revision of the relevant standards and codes in effect shall apply, unless otherwise expressly stated in the Contract. Where such standards and codes are national, or relate to a particular country or region, other authoritative standards that

ensure a substantially equal or higher quality than the standards and codes specified will be accepted subject to the Procuring Entity's Representative's prior review and written consent. Differences between the standards specified and the proposed alternative standards shall be fully described in writing by the Contractor and submitted to the Procuring Entity's Representative at least twenty-eight (28) days prior to the date when the Contractor desires the Procuring Entity's Representative's consent. In the event the Procuring Entity's Representative determines that such proposed deviations do not ensure substantially equal or higher quality, the Contractor shall comply with the standards specified in the documents.

These notes are intended only as information for the Procuring Entity or the person drafting the Bidding Documents. They should not be included in the final Bidding Documents.

Interested bidders will be provided an electronic soft copy (MS Excel file format) of the Blank Program of Works - Bill of Quantities & Detailed Estimates upon purchase of the bid document.

**BLANK PROGRAM OF WORKS  
BILL OF QUANTITIES  
&  
DETAILED COST ESTIMATES**

**With instructions on the  
Quality Control Program (QCP)**  
*(Adoption of the DPWH's Blue Book – Standard Specifications for Public  
Works Structures)*

**MANJUYOD CENTRAL ELEMENTARY  
SCHOOL**  
MANJUYOD, NEGROS ORIENTAL

# CONTRACTOR'S LOGO / HEADERS

## PROGRAM OF WORKS

### BILL OF QUANTITIES

QRF 2022 - R VII - **NEGROS ORIENTAL** - \_\_\_\_

School : MANJUYOD CENTRAL ELEM. SCHOOL	Date:					
School I.D: 120395	Budget Allocation: <span style="float: right;">PHP 11,766,399.62</span>					
Region : VII - CENTRAL VISAYAS	Engineering and Admin. Overhead:PHP 0.00					
Division: NEGROS ORIENTAL	Approved Budget for the Contract:PHP 11,766,399.62					
Project Title:  PROPOSED CONSTRUCTION OF ONE (1) STOREY - TWO (2) CLASSROOMS SCHOOL BUILDING (WITH COMMON TOILET) & CONSTRUCTION OF ONE (1) STOREY - THREE (3) CLASSROOMS SCHOOL BUILDING (WITH COMMON TOILET)	Completion Period: <span style="float: right;">210 CALENDAR DAYS</span>					
	Minimum Required Manpower:					
	<table style="width: 100%; border: none;"> <tr> <td style="width: 33%;">General Foreman</td> <td style="width: 33%;">Welder</td> <td style="width: 33%;">Carpenter</td> </tr> <tr> <td>Helper</td> <td>Mason</td> <td>Painter</td> </tr> </table>	General Foreman	Welder	Carpenter	Helper	Mason
General Foreman	Welder	Carpenter				
Helper	Mason	Painter				
Location:  <b>MANJUYOD, NEGROS ORIENTAL</b>	Minimum Required Equipment:					
	<table style="width: 100%; border: none;"> <tr> <td style="width: 50%;">Hand Tools</td> <td style="width: 50%;">Welding Machine</td> </tr> <tr> <td>One-Bagger Mixer</td> <td>Bar Cutter</td> </tr> </table>	Hand Tools	Welding Machine	One-Bagger Mixer	Bar Cutter	
	Hand Tools	Welding Machine				
One-Bagger Mixer	Bar Cutter					

ITEM NO.	Item Description	% of Total	Unit	Quantity	Total Cost	Remarks
	<b>I. DIRECT COST</b>					
	GENERAL REQUIREMENTS		lot	1.00		
<b>CONSTRUCTION OF ONE (1) STOREY - TWO (2) CLASSROOMS SCHOOL BUILDING (WITH COMMON TOILET)</b>						
1.0000	Earthworks		lot	1.00		
2.0000	Concreting Works (3000 psi)		cu m	99.72		
3.0000	Rebar Works		kg	15,735.67		
4.0000	Formworks		lot	1.00		
5.0000	Masonry Works		sq m	543.59		
6.0000	Doors and Windows		lot	1.00		
7.0000	Steel Works		lot	1.00		
8.0000	Roofing Works		lm	289.91		
9.0000	Ceiling and Carpentry Works		sq m	253.77		
10.0000	Electrical Works		lot	1.00		
11.0000	Plumbing Works		lot	1.00		
	Rain Water Collector		lot	1.00		
12.0000	Sanitary Works		lot	1.00		
13.0000	Painting Work		sq m	895.18		
15.0000	Waterproofing		lot	1.00		
14.0000	Tile Work		sq m	93.25		
<b>MANJUYOD CES - SPED CENTER</b>						
<b>CONSTRUCTION OF ONE (1) STOREY - THREE (3) CLASSROOMS SCHOOL BUILDING (WITH COMMON TOILET)</b>						
1.0000	Earthworks		lot	1.00		
2.0000	Concreting Works (3000 psi)		cu m	=131.46		
3.0000	Rebar Works		kg	20,460.01		

4.0000	Formworks		lot	1.00		
5.0000	Masonry Works		sq m	703.17		
6.0000	Doors and Windows		lot	1.00		
7.0000	Steel Works		lot	1.00		
8.0000	Roofing Works		lm	393.45		
9.0000	Ceiling and Carpentry Works		sq m	345.03		
10.0000	Electrical Works		lot	1.00		
11.0000	Plumbing Works		lot	1.00		
	Rain Water Collector		lot	1.00		
12.0000	Sanitary Works		lot	1.00		
13.0000	Painting Works		sq m	1,144.22		
15.0000	Waterproofing		lot	1.00		
14.0000	Tile Works		sq m	93.25		
	<b>Sub-Total</b>					
	<b>II. INDIRECT COST 17% of (I - Gen. Req)</b>					
	Overhead Expenses (5%)					
	Contingencies (3%)					
	Miscellaneous (1%)					
	Contractor's Profit (8%)					
	<b>Sub-Total</b>					
	<b>III. TAX 5% of (I+II)</b>					
	<b>Sub-Total</b>					
	<b>IV. TOTAL CONSTRUCTION COST (I + II + III)</b>					

Prepared by:

\_\_\_\_\_  
Contractor's Authorized Representative Name & Signature

# CONTRACTOR'S LOGO / HEADER

## PROGRAM OF WORKS

### DETAILED COST ESTIMATE

PROJECT: **PROPOSED CONSTRUCTION OF ONE (1) STOREY - TWO (2) CLASSROOMS SCHOOL BUILDING (WITH COMMON TOILET) & CONSTRUCTION OF ONE (1) STOREY – THREE (3) CLASSROOMSCHOOL BUILDING (WITH COMMON TOILET)**

SCHOOL: **MANJUYOD CENTRAL ELEMENTARY SCHOOL**

LOCATION: **MANJUYOD, NEGROS ORIENTAL**

OWNER : **DEPARTMENT OF EDUCATION**

ITEM NO.	DESCRIPTION	UNIT	QTY	UNIT COST		TOTAL COST		GRAND TOTAL
				MATERIAL	LABOR	MATERIAL	LABOR	
	<b>GENERAL REQUIREMENTS</b>							
	Mobilization/Temporary Structures, Utilities and Services/Demobilization	lot	1.00					
	Project Billboard	lot	1.00					
	Safety and Health	lot	1.00					
	Fire Clearance/ Permit Fee	lot	1.00					
	Other Permit Fee	lot	1.00					
	<b>Sub-total</b>							
<b>CONSTRUCTION OF ONE (1) STOREY - TWO (2) CLASSROOMS SCHOOL BUILDING (WITH COMMON TOILET)</b>								
1.0000	<b>Earthworks</b>							
1.0100	Clearing and Grubbing	sq.m	242.25					
1.0200	Structural Excavation	cu.m	61.43					
1.0300	Backfilling and Compaction	cu.m	44.81					
1.0400	Gravel Bedding G-1	cu.m	32.50					
1.0500	Select Fill	cu.m	53.30					
1.0600	Soil Poisoning	sq m	266.48					
	Demolition	sq.m	118.75					
	<b>Sub-total</b>							
2.0000	<b>Concreting Works (3000 psi)</b>							
	Column Footing	cu.m	14.18					
2.0200	Portland Cement	bag	128.00					
2.0400	Crushed Gravel 1"	cu.m	14.25					
2.0500	Washed Sand	cu.m	7.25					
	Footing Tie Beam	cu.m	14.30					
2.0200	Portland Cement	bag	129.00					
2.0300	Crushed Gravel 3/4"	cu.m	14.50					
2.0500	Washed Sand	cu.m	7.25					
	Wall Footing	cu.m	1.03					
2.0200	Portland Cement	bag	10.00					
2.0300	Crushed Gravel 3/4"	cu.m	1.25					
2.0500	Washed Sand	cu.m	0.75					
	Columns/ Stiffener	cu.m	10.93					



2.0200	Portland Cement	bag	99.00					
2.0300	Crushed Gravel 3/4"	cu.m	11.00					
2.0500	Washed Sand	cu.m	5.50					
	Roof Beams/ LRB-1	cu.m	15.90					
2.0200	Portland Cement	bag	144.00					
2.0300	Crushed Gravel 3/4"	cu.m	16.00					
2.0500	Washed Sand	cu.m	8.00					
	CB-1/ GB-1	cu.m	5.76					
2.0200	Portland Cement	bag	52.00					
2.0300	Crushed Gravel 3/4"	cu.m	6.00					
2.0500	Washed Sand	cu.m	3.00					
	R. C. Concrete Gutter/ Parapet Wall	cu.m	10.59					
2.0200	Portland Cement	bag	96.00					
2.0300	Crushed Gravel 3/4"	cu.m	10.75					
2.0500	Washed Sand	cu.m	5.50					
	Stair	cu.m	1.28					
2.0200	Portland Cement	bag	12.00					
2.0300	Crushed Gravel 3/4"	cu.m	1.50					
2.0500	Washed Sand	cu.m	0.75					
	Concrete Bench	cu.m	0.31					
2.0200	Portland Cement	bag	3.00					
2.0300	Crushed Gravel 3/4"	cu.m	0.50					
2.0500	Washed Sand	cu.m	0.25					
	Slab on Fill	cu.m	22.80					
2.0200	Portland Cement	bag	206.00					
2.0300	Crushed Gravel 3/4"	cu.m	23.00					
2.0500	Washed Sand	cu.m	11.50					
	Ramp on Fill	cu.m	1.25					
2.0200	Portland Cement	bag	12.00					
2.0300	Crushed Gravel 3/4"	cu.m	1.25					
2.0500	Washed Sand	cu.m	0.75					
	Handwashing with Concrete Platform	cu.m	1.41					
2.0200	Portland Cement	bag	13.00					
2.0300	Crushed Gravel 3/4"	cu.m	1.50					
2.0500	Washed Sand	cu.m	0.75					
	<b>Sub-total</b>							
3.0000	<b>Rebar Works</b>							
	<i>Column Footing</i>	<i>kg</i>	<i>766.46</i>					
	<i>Footing Tie Beam</i>	<i>kg</i>	<i>1,913.56</i>					
	<i>Columns</i>	<i>kg</i>	<i>5,367.19</i>					
	<i>Roof Beams/ LRB-1</i>	<i>kg</i>	<i>2,336.61</i>					
	<i>CB-1/ GB-1</i>	<i>kg</i>	<i>692.51</i>					
3.0500	Deformed Round Bars, Grade 40	kg	11,076.34					
	<i>Footing Tie Beam</i>	<i>kg</i>	<i>812.70</i>					
	<i>Wall Footing</i>	<i>kg</i>	<i>37.82</i>					
	<i>Columns</i>	<i>kg</i>	<i>600.78</i>					
	<i>Stiffener</i>	<i>kg</i>	<i>103.18</i>					
	<i>Roof Beams/ LRB-1</i>	<i>kg</i>	<i>923.84</i>					

	CB-1/ GB-1	kg	316.03				
	R. C. Concrete Gutter/ Parapet Wall	kg	643.75				
	Stair	kg	78.07				
	Concrete Bench	kg	29.48				
	Slab on Fill	kg	972.66				
	Ramp on Fill	kg	46.19				
	Handwashing with Concrete Platform	kg	94.84				
3.0900	Deformed Round Bars, Grade 33	kg	4,659.33				
3.1200	G.I. Tie Wire	kg	315.00				
	<b>Sub-total</b>						
4.0000	<b>Formworks</b>						
	Footing Tie Beam	sq.m	150.15				
4.0100	Coco Lumber	bd.ft	765.90				
4.0200	Plywood Ordinary, 1/4" x 4' x 8'	pc	26.00				
4.0400	CWN, Assorted	kg	11.00				
	Columns/ Stiffener	sq.m	148.86				
4.0100	Coco Lumber	bd.ft	759.30				
4.0200	Plywood Ordinary, 1/4" x 4' x 8'	pc	26.00				
4.0400	CWN, Assorted	kg	11.00				
	Roof Beams/ LRB-1	sq.m	168.54				
4.0100	Coco Lumber	bd.ft	859.80				
4.0200	Plywood Ordinary, 1/4" x 4' x 8'	pc	29.00				
4.0400	CWN, Assorted	kg	13.00				
	CB-1/ GB-1	sq.m	64.38				
4.0100	Coco Lumber	bd.ft	328.50				
4.0200	Plywood Ordinary, 1/4" x 4' x 8'	pc	12.00				
4.0400	CWN, Assorted	kg	5.00				
	R. C. Concrete Gutter/ Parapet Wall	sq.m	163.20				
4.0100	Coco Lumber	bd.ft	832.50				
4.0200	Plywood Ordinary, 1/4" x 4' x 8'	pc	28.00				
4.0400	CWN, Assorted	kg	12.00				
	Stair	sq.m	2.84				
4.0100	Coco Lumber	bd.ft	14.70				
4.0200	Plywood Ordinary, 1/4" x 4' x 8'	pc	1.00				
4.0400	CWN, Assorted	kg	1.00				
	Concrete Bench	sq.m	3.11				
4.0100	Coco Lumber	bd.ft	15.90				
4.0200	Plywood Ordinary, 1/4" x 4' x 8'	pc	1.00				
4.0400	CWN, Assorted	kg	1.00				
	Handwashing	sq.m	6.40				
4.0100	Coco Lumber	bd.ft	32.70				
4.0200	Plywood Ordinary, 1/4" x 4' x 8'	pc	2.00				
4.0400	CWN, Assorted	kg	1.00				

	<b>Sub-total</b>							
5.0000	<b>Masonry Works</b>							
	Masonry Wall	sq.m	305.09					
5.0200	CHB 6" thk	pc	3,327.00					
5.0300	CHB 4" thk	pc	488.00					
2.0200	Portland Cement	bag	153.00					
2.0500	Washed Sand	cu.m	13.00					
5.0400	10mm x 6m RSB	kg	405.00					
3.1200	G.I. Tie Wire	kg	9.00					
	Plastering	sq.m	610.17					
2.0200	Portland Cement	bag	202.00					
2.0500	Washed Sand	cu.m	21.00					
	Floor Topping	sq.m	238.50					
2.0200	Portland Cement	bag	158.00					
2.0500	Washed Sand	cu.m	16.00					
	<b>Sub-total</b>							
6.0000	<b>Doors and Windows</b>							
6.0300	D-1, (0.90m x 2.10m) KD and Termite - treated Panel Door Type Hinged Door and Fixed Glass Transom on 50mm x 150mm Wood Jamb/ Frame and Lever - type Knob	set	4.00					
6.0490	D-2, (0.80m x 2.10m) Hollow Core Flush Type Swing Door in 50mm x 150mm Guijo/ Yakal Jamb with Marine Plywood (two face) with Hardware and Accessories and Cylindrical Door Knob.	set	2.00					
6.0501	D-3, (0.90m x 2.10m) KD and Termite - treated Panel Door Type Hinged Door and Fixed Glass Transom on 50mm x 150mm Wood Jamb/ Frame and Lever - type Knob (Provide S/S Kickplate)	set	1.00					
6.0601	D-4, (0.70m x 1.30m) Swing Door on 50mm x 150mm Guijo/ Yakal Jamb Frame with Marine Plywood (two face) complete with Hardware and Accessories with Door Bolt	set	4.00					
6.0701	W - 1, (2.60m x 1.60m) Jalousie Window with 6mm Clear Glass Blades on 50mm x 150mm KD Wood and Termite - Treated (Yakal/ Guijo) or Concrete Jamb	set	4.00					
6.4381	W - 2, (1.80m x 1.60m) Jalousie Window with 6mm Clear Glass Blades on 50mm x 150mm KD Wood and Termite - Treated (Yakal/ Guijo) or Concrete Jamb	set	4.00					

6.4480	W - 3, (1.2 x 0.6 m) Awning Window with 6mm Clear Glass Blades on Steel Jamb/ Framing	set	1.00					
6.4490	W - 4, (0.6 x 0.6 m) Awning Window with 6mm Clear Glass Blades on Steel Jamb/ Framing	set	4.00					
	Window Grille (WG - 1)	set	4.00					
	Window Grille (WG - 2)	set	4.00					
	<b>Sub-total</b>							
7.0000	<b>Steel Works</b>							
7.0200	LC 150 x 50 x 25 x 6.0mm	kg	7,287.39					
7.0800	L 90 x 90 x 6mm	kg	822.60					
7.0800	L 90 x 90 x 6mm	kg	782.15					
7.0900	L 50 x 50 x 6mm	kg	79.56					
7.0900	L 50 x 50 x 6mm	kg	887.89					
7.1000	L 50 x 50 x 5mm	kg	18.20					
7.0410	L 100 x 100 x 6.0mm	kg	183.40					
7.0300	L 125 x 125 x 6mm	kg	63.14					
7.0300	L 125 x 75 x 6mm	kg	20.09					
7.1400	Steel Plate 1.20m x 2.40m x 16mm thk	pc	0.25					
7.1100	Steel Plate 1.20m x 2.40m x 6mm thk	pc	2.50					
7.1500	Anchor Bolt with Nuts and Washer, 20mmØ x 50mm x 300mm	pc	40.00					
7.1600	Anchor Bolt with Nuts and Washer, 12mmØ x 50mm x 150mm	pc	88.00					
7.1700	Anchor Bolt with Nuts and Washer, 10mmØ x 50mm x 125mm	pc	20.00					
7.1800	Machine Bolts ( 6 mm dia. )	pc	792.00					
7.1901	Plain Round Bar 12mmØ x 6m	pc	19.00					
7.2100	Turn Buckle 12 mmØ	pc	16.00					
7.2300	10mmØ Sag Rods with Standard Nuts and Washers	pc	21.00					
7.3500	50 mmØ Stainless Steel Pipe	pc	7.00					
7.3600	Welding Rod	kg	224.00					
	<b>Sub-total</b>							
8.0000	<b>Roofing Works</b>							
8.0600	G.I. Long-Span Roofing, Corrugated, Pre-Painted, 1220mm x 0.5mm BMT	lm	289.91					
8.0700	G.I. Ridge Roll, Preformed, Pre-Painted, 0.610m x 2.440m x 0.5mm BMT	pc	12.00					
8.0800	G.I. Flashing, Preformed, Pre-Painted, 0.610m x 2.440m x 0.5mm BMT	pc	10.00					
8.0900	J-Bolt (6mm dia.)	pc	3,696.00					
8.1000	Teckscrew 2-1/2"	pc	528.00					
8.1300	Roof Sealant	L	5.00					

	<b>Sub-total</b>							
9.0000	<b>Ceiling and Carpentry Works</b>							
	Interior Ceiling	sq.m	178.50					
7.0810	L 75 x 75 x 6mm	kg	901.74					
7.0900	L 50 x 50 x 6mm	kg	563.55					
7.1800	6 mm Machine bolts with nuts and washers	pc	95.00					
	50 mm x 50 mm Ceiling Joist	bd.ft	714.71					
	50 mm x 50 mm Wooden Hanger	bd.ft	63.33					
9.1700	Rough Lumber, Sun Dried, Tanguile	bd.ft	778.04					
9.0200	Plywood, Ordinary 1/4" x 4' x 8'	pc	62.00					
9.2100	Finishing Nails	kg	4.00					
4.0400	CWN, Assorted	kg	15.00					
9.2200	Concrete Nails	kg	4.00					
9.1900	Wood Preservative, Brown	L	6.00					
	Exterior Ceiling	sq.m	63.75					
7.0810	L 75 x 75 x 6mm	kg	322.05					
7.0900	L 50 x 50 x 6mm	kg	112.71					
7.1800	6 mm Machine bolts with nuts and washers	pc	22.00					
	50 mm x 50 mm Ceiling Joist	bd.ft	265.21					
	50 mm x 50 mm Wooden Hanger	bd.ft	13.67					
9.1700	Rough Lumber, Sun Dried, Tanguile	bd.ft	278.88					
9.0200	Plywood, Ordinary 1/4" x 4' x 8'	pc	23.00					
9.1400	25mm x 25mm x 300mm Wood slats @25mm clear spacing ceiling ventilation (provide stainless steel wire mesh inside)	pc	5.00					
9.2100	Finishing Nails	kg	2.00					
4.0400	CWN, Assorted	kg	6.00					
9.2200	Concrete Nails	kg	2.00					
9.1900	Wood Preservative, Brown	L	2.00					
	Blackboards (2 Set)	sq.m	11.52					
9.1800	S4S Lumber, Kiln Dried, Tanguile	bd.ft	74.00					
9.2000	Lawanit, 1/4" thk	pc	4.00					
9.2100	Finishing Nails	kg	1.00					
4.0400	CWN, Assorted	kg	2.00					
9.2200	Concrete Nails	kg	1.00					
	<b>Sub-total</b>							
10.0000	<b>Electrical Works</b>							
	Roughing-ins							
10.0200	Electrical Conduit uPVC, 20mmØ	pc	128.00					
	RSC 32mmØ	pc	35.00					
10.1000	Entrance Cap 32mm dia.	pc	1.00					
10.1200	Junction Box, 4" x 4" G.I.	pc	21.00					

10.1300	Utility Box, 2" x 4" G.I.	pc	22.00					
10.1400	Grounding Rod, 2.4m x 16mm dia.	pc	1.00					
	Wires & Fixtures							
10.1600	3.5 mm <sup>2</sup> THHN Wire, Stranded	m	763.00					
10.1710	8.0 mm <sup>2</sup> THHN Wire, Stranded	m	206.00					
10.2200	3.5 mm <sup>2</sup> TW(G) Wire, Stranded	m	382.00					
10.2300	5.5 mm <sup>2</sup> TW(G) Wire, Stranded	m	103.00					
10.2700	Duplex Convenience Outlet, Grounding Type, 16A, 250V	set	4.00					
10.2800	Duplex Convenience Outlet, Grounding Type, 16A, 250V (WP)	set	2.00					
10.2900	1 Gang Wall Switches in One Switch Plate (16 AMP, 230V)	set	6.00					
10.3100	2 Gang Wall Switches in One Switch Plate (16 AMP, 230V)	set	2.00					
10.3300	Three Way Wall Switch (10 AMP, 230 V)	set	2.00					
10.3400	2 - 36W, 230V, 60Hz, T5 LED Lighting Fixture, (Box Type)	set	12.00					
10.3500	1 - 36W, 230V, 60Hz, T5 LED Lighting Fixture, (Box Type)	set	6.00					
10.5400	Orbit Fan with Fan Switch 1600 - 4500 CFM	set	8.00					
	Panel Box, Flush Type, 6 Branches	set	1.00					
10.4100	Circuit Breaker, 20A 2P	set	5.00					
10.4400	Circuit Breaker, 50A 2P	set	1.00					
10.4900	Vibrating Bell 8"	set	1.00					
10.5000	Push Button, 10A, 230V	set	1.00					
10.5500	Electrical Tape	pc	12.00					
	<b>Sub-total</b>							
11.0000	<b>Plumbing Works</b>							
11.0200	Water Closet 1.6gpf with Accessories	set	5.00					
11.0100	Water Closet Flange	set	5.00					
11.0300	Urinal 0.8gpf	set	2.00					
11.0400	Concrete Counter Sink Type, with Lever Type Faucet and Complete Accessories	set	2.00					
11.0600	Lavatory, Pedestal Type with Accessories	set	1.00					
11.0500	Faucet, Hose Bibb, Brass 1/2"Ø	pc	25.00					
11.4400	S.S. Grab Rail 1-1/2"Ø	set	5.00					
11.4410	S.S. Floor Drain 4" x 4"	set	16.00					
11.4300	Tissue Holder	pc	5.00					
11.4500	Mirror	sq.ft	24.00					

11.4200	Teflon Tape	roll	4.00					
11.0900	PP-R Pipe 1"Ø x 4.0m	pc	11.00					
11.1000	PP-R Pipe 3/4"Ø x 4.0m	pc	18.00					
11.2000	PP-R Elbow 90° x 1"Ø	pc	6.00					
11.2100	PP-R Elbow 90° x 3/4"Ø	pc	25.00					
11.2600	PP-R Tee, 3/4"Ø	pc	28.00					
11.2900	PP-R Tee Reducer, 1" x 3/4"Ø	pc	3.00					
11.3300	PP-R Plug, 3/4"Ø	pc	14.00					
11.1400	PP-R Coupling, 1"Ø	pc	6.00					
11.1700	PP-R Coupling Reducer, 1" x 3/4"Ø	pc	1.00					
11.3900	Check Valve, Horizontal, 1"Ø	pc	1.00					
11.3700	Gate Valve, 1"Ø	pc	2.00					
11.3800	Gate Valve, 3/4"Ø	pc	5.00					
	<b>Sub-total</b>							
	<b>Rain Water Collector</b>							
	Filter Tank/Rain Water Harvesting Tank							
	1.0m x 1.0m x 1.0m Intermediate Bulk Container (IBC), 1000L Capacity with tube cage and pallet	pc	3.00					
2.0500	Washed Sand	cu.m	0.15					
	Pebbles, 5mm	cu.m	0.10					
	Pebbles, 10mm	cu.m	0.15					
	Granulated Carbon	cu.m	0.15					
2.0300	Crushed Gravel 3/4"	cu.m	0.15					
12.0500	PVC Sanitary Pipe 4"Ø x 3.0m	pc	10.00					
12.0700	PVC Sanitary Pipe 2"Ø x 3.0m	pc	1.00					
	CPVC Pipe 2" dia.	pcs	4.00					
	CPVC Pipe 1" dia.	pcs	4.00					
12.1600	PVC Sanitary Wye 4" x 4"	pc	6.00					
12.2110	PVC Sanitary Tee 4" x 4"	pc	1.00					
12.1300	PVC Sanitary Elbow 1/8 x 4"Ø	pc	6.00					
12.0900	PVC Sanitary Elbow 90° x 4"Ø	pc	10.00					
12.1100	PVC Sanitary Elbow 90° x 2"Ø	pc	7.00					
12.1110	PVC Sanitary Elbow 90° x 1"Ø	pc	2.00					
12.2400	Brass Cleanout 4" x 4"	pc	1.00					
	Gate Valve, 4" dia.	pcs	1.00					
11.3600	Gate Valve, 2"Ø	pc	2.00					
11.3700	Gate Valve, 1"Ø	pc	1.00					
11.3900	Check Valve, Horizontal, 1"Ø	pc	1.00					
12.3000	PVC Cement	can	2.00					
	50mm Vent Screen	pcs	3.00					
	Male adapter wit gasket and nuts	pcs	6.00					
	RWHT Support							

7.0410	L 100 x 100 x 6.0mm	kg	84.00					
7.0810	L 75 x 75 x 6mm	kg	311.69					
7.0710	L 65 x 65 x 6.0mm	kg	86.43					
7.1100	Steel Plate 1.20m x 2.40m x 6mm thk	pc	1.00					
7.3600	Welding Rod	kg	9.64					
13.1100	Primer, Zinc Chromate	gal	3.00					
	Pedestal/Footing	cu.m	0.09					
2.0200	Portland Cement	bag	1.00					
2.0500	Washed Sand	cu.m	0.25					
2.0300	Crushed Gravel 3/4"	cu.m	0.25					
3.1000	D10mm x 6.00 mts RSB	pc	2.00					
3.1100	D12mm x 6.00 mts RSB	pc	1.00					
3.0600	D16mm x 6.00 mts RSB	pc	1.00					
3.1200	G.I. Tie Wire	kg	0.45					
	<b>Sub-Total</b>							
12.0000	<b>Sanitary Works</b>							
12.0110	Three Chamber Septic Vault	unit	1.00					
12.0100	Catch Basin	unit	16.00					
12.2800	Closet Bend, 4"	pc	5.00					
12.0300	Stainless Steel Vent Protection Screen, 2"	pc	1.00					
12.0400	PVC Sanitary Pipe 6"Ø x 3.0m	pc	3.00					
12.0500	PVC Sanitary Pipe 4"Ø x 3.0m	pc	55.00					
12.0700	PVC Sanitary Pipe 2"Ø x 3.0m	pc	21.00					
	PVC Sanitary Pipe 1-1/2"Ø	pc	6.00					
12.1600	PVC Sanitary Wye 4" x 4"	pc	33.00					
	PVC Sanitary Wye 4" x 1- 1/2"	pc	7.00					
	PVC Sanitary Wye 1-1/2" x 1-1/2"	pc	7.00					
12.1300	PVC Sanitary Elbow 1/8 x 4"Ø	pc	4.00					
	PVC Sanitary Elbow 1/8 x 1-1/2"Ø	pc	14.00					
12.0900	PVC Sanitary Elbow 90° x 4"Ø	pc	24.00					
12.1100	PVC Sanitary Elbow 90° x 2"Ø	pc	12.00					
12.2100	PVC Sanitary Tee 6" x 6"	pc	3.00					
12.2110	PVC Sanitary Tee 4" x 4"	pc	2.00					
12.2200	PVC Sanitary Tee 2" x 2"	pc	19.00					
12.2600	PVC P-Trap 4"	pc	16.00					
	PVC P-Trap 1-1/2"'''	pc	7.00					
12.2400	Brass Cleanout 4" x 4"	pc	8.00					
12.2900	Roof Drain	pc	8.00					
12.3000	PVC Cement	can	4.00					
	<b>Sub-total</b>							
13.0000	<b>Painting Works</b>							
	Concrete surfaces	sq.m	610.17					
13.0100	Neutralizer	gal	8.00					



13.0200	Latex, Flat	gal	25.00					
13.0300	Masonry Putty	gal	25.00					
13.0400	Latex, Semi Gloss	gal	25.00					
13.0500	Acri Color	qrt	7.00					
	Wood surfaces	sq.m	285.01					
13.0600	Enamel, Flatwall	gal	15.00					
13.0700	Glazing Putty	gal	15.00					
13.0800	Enamel, Semi Gloss	gal	15.00					
13.0900	Paint Thinner	gal	8.00					
	Steel Surfaces							
13.1100	Primer, Zinc Chromate	gal	1.00					
	<b>Sub-total</b>							
15.0000	<b>Waterproofing</b>							
15.0100	Waterproofing, Cementitious	gal	25.00					
	<b>Sub-total</b>							
14.0000	<b>Tile Works</b>							
	Toilet (Wall)	sq.m	45.53					
14.0110	Glazed Wall Tiles 20cm x 20cm	pc	1,196.00					
14.0300	Tile Adhesive 25 kg/bag	bag	9.00					
14.0400	Tile Trim 6mm	pc	17.00					
14.0500	Tile Grout 5 kg/bag	bag	4.00					
	Toilet (Flooring)	sq.m	22.64					
	Unglazed Floor Tiles 30cm x 30cm	pc	265.00					
14.0300	Tile Adhesive 25 kg/bag	bag	5.00					
14.0500	Tile Grout 5 kg/bag	bag	2.00					
	Handwashing Sink	sq.m	13.88					
14.0110	Glazed Wall Tiles 20cm x 20cm	pc	365.00					
14.0300	Tile Adhesive 25 kg/bag	bag	3.00					
14.0400	Tile Trim 6mm	pc	13.00					
14.0500	Tile Grout 5 kg/bag	bag	2.00					
	Concrete Platform	sq.m	11.20					
	Unglazed Floor Tiles 30cm x 30cm	pc	131.00					
14.0300	Tile Adhesive 25 kg/bag	bag	3.00					
14.0500	Tile Grout 5 kg/bag	bag	1.00					
	<b>Sub-total</b>							
<b>MANJUYOD CES - SPED CENTER</b>								
<b>CONSTRUCTION OF ONE (1) STOREY - THREE (3) CLASSROOMS SCHOOL BUILDING (WITH COMMON TOILET)</b>								
1.0000	<b>Earthworks</b>							
1.0100	Clearing and Grubbing	sq.m	327.75					
1.0200	Structural Excavation	cu.m	78.98					
1.0300	Backfilling and Compaction	cu.m	57.61					
1.0400	Gravel Bedding G-1	cu.m	43.55					
1.0500	Select Fill	cu.m	72.11					
1.0600	Soil Poisoning	sq m	360.53					
	Demolition	sq.m	135.00					
	<b>Sub-total</b>							

2.0000	<b>Concreting Works (3000 psi)</b>						
	Column Footing	cu.m	18.23				
2.0200	Portland Cement	bag	165.00				
2.0400	Crushed Gravel 1"	cu.m	18.25				
2.0500	Washed Sand	cu.m	9.25				
	Footing Tie Beam	cu.m	18.90				
2.0200	Portland Cement	bag	171.00				
2.0300	Crushed Gravel 3/4"	cu.m	19.00				
2.0500	Washed Sand	cu.m	9.50				
	Wall Footing	cu.m	1.03				
2.0200	Portland Cement	bag	10.00				
2.0300	Crushed Gravel 3/4"	cu.m	1.25				
2.0500	Washed Sand	cu.m	0.75				
	Columns/ Stiffener	cu.m	14.43				
2.0200	Portland Cement	bag	130.00				
2.0300	Crushed Gravel 3/4"	cu.m	14.50				
2.0500	Washed Sand	cu.m	7.25				
	Roof Beams/ LRB-1	cu.m	20.50				
2.0200	Portland Cement	bag	185.00				
2.0300	Crushed Gravel 3/4"	cu.m	20.50				
2.0500	Washed Sand	cu.m	10.25				
	CB-1/ GB-1	cu.m	7.68				
2.0200	Portland Cement	bag	70.00				
2.0300	Crushed Gravel 3/4"	cu.m	7.75				
2.0500	Washed Sand	cu.m	4.00				
	R. C. Concrete Gutter/ Parapet Wall	cu.m	14.91				
2.0200	Portland Cement	bag	135.00				
2.0300	Crushed Gravel 3/4"	cu.m	15.00				
2.0500	Washed Sand	cu.m	7.50				
	Stair	cu.m	1.28				
2.0200	Portland Cement	bag	12.00				
2.0300	Crushed Gravel 3/4"	cu.m	1.50				
2.0500	Washed Sand	cu.m	0.75				
	Concrete Bench	cu.m	0.52				
2.0200	Portland Cement	bag	5.00				
2.0300	Crushed Gravel 3/4"	cu.m	0.75				
2.0500	Washed Sand	cu.m	0.50				
	Slab on Fill	cu.m	31.35				
2.0200	Portland Cement	bag	283.00				
2.0300	Crushed Gravel 3/4"	cu.m	31.50				
2.0500	Washed Sand	cu.m	15.75				
	Ramp on Fill	cu.m	1.25				
2.0200	Portland Cement	bag	12.00				
2.0300	Crushed Gravel 3/4"	cu.m	1.25				
2.0500	Washed Sand	cu.m	0.75				
	Handwashing with Concrete Platform	cu.m	1.41				
2.0200	Portland Cement	bag	13.00				
2.0300	Crushed Gravel 3/4"	cu.m	1.50				

2.0500	Washed Sand	cu.m	0.75					
	<b>Sub-total</b>							
3.0000	<b>Rebar Works</b>							
	Column Footing	kg	985.45					
	Footing Tie Beam	kg	2,514.93					
	Columns	kg	6,891.79					
	Roof Beams/ LRB-1	kg	3,018.38					
	CB-1/ GB-1	kg	922.88					
3.0500	Deformed Round Bars, Grade 40	kg	14,333.43					
	Footing Tie Beam	kg	1,067.71					
	Wall Footing	kg	37.82					
	Columns	kg	769.73					
	Stiffener	kg	133.11					
	Roof Beams/ LRB-1	kg	1,180.26					
	CB-1/ GB-1	kg	417.63					
	R. C. Concrete Gutter/ Parapet Wall	kg	912.25					
	Stair	kg	78.07					
	Concrete Bench	kg	49.14					
	Slab on Fill	kg	1,339.82					
	Ramp on Fill	kg	46.19					
	Handwashing with Concrete Platform	kg	94.84					
3.0900	Deformed Round Bars, Grade 33	kg	6,126.58					
3.1200	G.I. Tie Wire	kg	410.00					
	<b>Sub-total</b>							
4.0000	<b>Formworks</b>							
	Footing Tie Beam	sq.m	198.45					
4.0100	Coco Lumber	bd.ft	1,012.20					
4.0200	Plywood Ordinary, 1/4" x 4' x 8'	pc	34.00					
4.0400	CWN, Assorted	kg	15.00					
	Columns/ Stiffener	sq.m	189.93					
4.0100	Coco Lumber	bd.ft	968.70					
4.0200	Plywood Ordinary, 1/4" x 4' x 8'	pc	33.00					
4.0400	CWN, Assorted	kg	14.00					
	Roof Beams/ LRB-1	sq.m	216.84					
4.0100	Coco Lumber	bd.ft	1,106.10					
4.0200	Plywood Ordinary, 1/4" x 4' x 8'	pc	38.00					
4.0400	CWN, Assorted	kg	16.00					
	CB-1/ GB-1	sq.m	87.42					
4.0100	Coco Lumber	bd.ft	446.10					
4.0200	Plywood Ordinary, 1/4" x 4' x 8'	pc	15.00					
4.0400	CWN, Assorted	kg	7.00					
	R. C. Concrete Gutter/ Parapet Wall	sq.m	220.80					
4.0100	Coco Lumber	bd.ft	1,126.20					
4.0200	Plywood Ordinary, 1/4" x 4' x 8'	pc	38.00					

4.0400	CWN, Assorted	kg	16.00					
	Stair	sq.m	2.84					
4.0100	Coco Lumber	bd.ft	14.70					
4.0200	Plywood Ordinary, 1/4" x 4' x 8'	pc	1.00					
4.0400	CWN, Assorted	kg	1.00					
	Concrete Bench	sq.m	5.19					
4.0100	Coco Lumber	bd.ft	26.70					
4.0200	Plywood Ordinary, 1/4" x 4' x 8'	pc	1.00					
4.0400	CWN, Assorted	kg	1.00					
	Handwashing	sq.m	6.40					
4.0100	Coco Lumber	bd.ft	32.70					
4.0200	Plywood Ordinary, 1/4" x 4' x 8'	pc	2.00					
4.0400	CWN, Assorted	kg	1.00					
	<b>Sub-total</b>							
5.0000	<b>Masonry Works</b>							
	Masonry Wall	sq.m	379.17					
5.0200	CHB 6" thk	pc	4,191.00					
5.0300	CHB 4" thk	pc	550.00					
2.0200	Portland Cement	bag	190.00					
2.0500	Washed Sand	cu.m	17.00					
5.0400	10mm x 6m RSB	kg	503.00					
3.1200	G.I. Tie Wire	kg	11.00					
	Plastering	sq.m	758.35					
2.0200	Portland Cement	bag	251.00					
2.0500	Washed Sand	cu.m	26.00					
	Floor Topping	sq.m	324.00					
2.0200	Portland Cement	bag	214.00					
2.0500	Washed Sand	cu.m	22.00					
	<b>Sub-total</b>							
6.0000	<b>Doors and Windows</b>							
6.0300	D-1, (0.90m x 2.10m) KD and Termite - treated Panel Door Type Hinged Door and Fixed Glass Transom on 50mm x 150mm Wood Jamb/ Frame and Lever - type Knob	set	6.00					
6.0490	D-2, (0.80m x 2.10m) Hollow Core Flush Type Swing Door in 50mm x 150mm Guijo/ Yakal Jamb with Marine Plywood (two face) with Hardware and Accessories and Cylindrical Door Knob.	set	2.00					
6.0501	D-3, (0.90m x 2.10m) KD and Termite - treated Panel Door Type Hinged Door and Fixed Glass Transom on 50mm x 150mm Wood Jamb/ Frame and Lever - type Knob (Provide S/S Kickplate)	set	1.00					

6.0601	D-4, (0.70m x 1.30m) Swing Door on 50mm x 150mm Guijo/ Yakal Jamb Frame with Marine Plywood (two face) complete with Hardware and Accessories with Door Bolt	set	4.00					
6.0701	W - 1, (2.60m x 1.60m) Jalousie Window with 6mm Clear Glass Blades on 50mm x 150mm KD Wood and Termite - Treated (Yakal/ Guijo) or Concrete Jamb	set	6.00					
6.4381	W - 2, (1.80m x 1.60m) Jalousie Window with 6mm Clear Glass Blades on 50mm x 150mm KD Wood and Termite - Treated (Yakal/ Guijo) or Concrete Jamb	set	6.00					
6.4480	W - 3, (1.2 x 0.6 m) Awning Window with 6mm Clear Glass Blades on Steel Jamb/ Framing	set	1.00					
6.4490	W - 4, (0.6 x 0.6 m) Awning Window with 6mm Clear Glass Blades on Steel Jamb/ Framing	set	4.00					
	Window Grille (WG - 1)	set	6.00					
	Window Grille (WG - 2)	set	6.00					
	<b>Sub-total</b>							
7.0000	<b>Steel Works</b>							
7.0200	LC 150 x 50 x 25 x 6.0mm	kg	9,859.41					
7.0800	L 90 x 90 x 6mm	kg	1,151.65					
7.0800	L 90 x 90 x 6mm	kg	1,095.00					
7.0900	L 50 x 50 x 6mm	kg	111.38					
7.0900	L 50 x 50 x 6mm	kg	1,243.05					
7.1000	L 50 x 50 x 5mm	kg	25.48					
7.0410	L 100 x 100 x 6.0mm	kg	183.40					
7.0300	L 125 x 125 x 6mm	kg	88.40					
7.0300	L 125 x 75 x 6mm	kg	20.09					
7.1400	Steel Plate 1.20m x 2.40m x 16mm thk	pc	0.50					
7.1100	Steel Plate 1.20m x 2.40m x 6mm thk	pc	3.75					
7.1500	Anchor Bolt with Nuts and Washer, 20mmØ x 50mm x 300mm	pc	56.00					
7.1600	Anchor Bolt with Nuts and Washer, 12mmØ x 50mm x 150mm	pc	88.00					
7.1700	Anchor Bolt with Nuts and Washer, 10mmØ x 50mm x 125mm	pc	28.00					
7.1800	Machine Bolts ( 6 mm dia. )	pc	1,144.00					
7.1901	Plain Round Bar 12mmØ x 6m	pc	27.00					
7.2100	Turn Buckle 12 mmØ	pc	24.00					
7.2300	10mmØ Sag Rods with Standard Nuts and Washers	pc	28.00					

7.3500	50 mmØ Stainless Steel Pipe	pc	7.00					
7.3600	Welding Rod	kg	304.00					
	<b>Sub-total</b>							
8.0000	<b>Roofing Works</b>							
8.0600	G.I. Long-Span Roofing, Corrugated, Pre-Painted, 1220mm x 0.5mm BMT	lm	393.45					
8.0700	G.I. Ridge Roll, Preformed, Pre-Painted, 0.610m x 2.440m x 0.5mm BMT	pc	16.00					
8.0800	G.I. Flashing, Preformed, Pre-Painted, 0.610m x 2.440m x 0.5mm BMT	pc	10.00					
8.0900	J-Bolt (6mm dia.)	pc	4,994.00					
8.1000	Teckscrew 2-1/2"	pc	624.00					
8.1300	Roof Sealant	L	7.00					
	<b>Sub-total</b>							
9.0000	<b>Ceiling and Carpentry Works</b>							
	Interior Ceiling	sq.m	241.50					
7.0810	L 75 x 75 x 6mm	kg	1,233.96					
7.0900	L 50 x 50 x 6mm	kg	762.45					
7.1800	6 mm Machine bolts with nuts and washers	pc	130.00					
	50 mm x 50 mm Ceiling Joist	bd.ft	965.16					
	50 mm x 50 mm Wooden Hanger	bd.ft	86.67					
9.1700	Rough Lumber, Sun Dried, Tanguile	bd.ft	1,051.83					
9.0200	Plywood, Ordinary 1/4" x 4' x 8'	pc	84.00					
9.2100	Finishing Nails	kg	5.00					
4.0400	CWN, Assorted	kg	19.00					
9.2200	Concrete Nails	kg	5.00					
9.1900	Wood Preservative, Brown	L	8.00					
	Exterior Ceiling	sq.m	86.25					
7.0810	L 75 x 75 x 6mm	kg	440.70					
7.0900	L 50 x 50 x 6mm	kg	152.49					
7.1800	6 mm Machine bolts with nuts and washers	pc	29.00					
	50 mm x 50 mm Ceiling Joist	bd.ft	358.18					
	50 mm x 50 mm Wooden Hanger	bd.ft	18.33					
9.1700	Rough Lumber, Sun Dried, Tanguile	bd.ft	376.51					
9.0200	Plywood, Ordinary 1/4" x 4' x 8'	pc	30.00					
9.1400	25mm x 25mm x 300mm Wood slats @25mm clear spacing ceiling ventilation (provide stainless steel wire mesh inside)	pc	7.00					
9.2100	Finishing Nails	kg	2.00					
4.0400	CWN, Assorted	kg	7.00					
9.2200	Concrete Nails	kg	2.00					

9.1900	Wood Preservative, Brown	L	3.00					
	Blackboards (3 Set)	sq.m	17.28					
9.1800	S4S Lumber, Kiln Dried, Tanguile	bd.ft	110.00					
9.2000	Lawanit, 1/4" thk	pc	6.00					
9.2100	Finishing Nails	kg	1.00					
4.0400	CWN, Assorted	kg	2.00					
9.2200	Concrete Nails	kg	1.00					
	<b>Sub-total</b>							
10.0000	<b>Electrical Works</b>							
	Roughing-ins							
10.0200	Electrical Conduit uPVC, 20mmØ	pc	153.00					
	RSC 32mmØ	pc	60.00					
10.1000	Entrance Cap 32mm dia.	pc	1.00					
10.1200	Junction Box, 4" x 4" G.I.	pc	28.00					
10.1300	Utility Box, 2" x 4" G.I.	pc	28.00					
10.1400	Grounding Rod, 2.4m x 16mm dia.	pc	1.00					
	Wires & Fixtures							
10.1600	3.5 mm <sup>2</sup> THHN Wire, Stranded	m	913.00					
10.1710	8.0 mm <sup>2</sup> THHN Wire, Stranded	m	356.00					
10.2200	3.5 mm <sup>2</sup> TW(G) Wire, Stranded	m	457.00					
10.2300	5.5 mm <sup>2</sup> TW(G) Wire, Stranded	m	178.00					
10.2700	Duplex Convenience Outlet, Grounding Type, 16A, 250V	set	6.00					
10.2800	Duplex Convenience Outlet, Grounding Type, 16A, 250V (WP)	set	3.00					
10.2900	1 Gang Wall Switches in One Switch Plate (16 AMP, 230V)	set	7.00					
10.3100	2 Gang Wall Switches in One Switch Plate (16 AMP, 230V)	set	3.00					
10.3300	Three Way Wall Switch (10 AMP, 230 V)	set	3.00					
10.3400	2 - 36W, 230V, 60Hz, T5 LED Lighting Fixture, (Box Type)	set	18.00					
10.3500	1 - 36W, 230V, 60Hz, T5 LED Lighting Fixture, (Box Type)	set	8.00					
10.5400	Orbit Fan with Fan Switch 1600 - 4500 CFM	set	12.00					
10.3800	Panel Box, Flush Type, 8 Branches	set	1.00					
10.4100	Circuit Breaker, 20A 2P	set	7.00					
10.4400	Circuit Breaker, 50A 2P	set	1.00					
10.4900	Vibrating Bell 8"	set	1.00					
10.5000	Push Button, 10A, 230V	set	1.00					
10.5500	Electrical Tape	pc	14.00					
	<b>Sub-total</b>							

11.0000	<b>Plumbing Works</b>							
11.0200	Water Closet 1.6gpf with Accessories	set	5.00					
11.0100	Water Closet Flange	set	5.00					
11.0300	Urinal 0.8gpf	set	2.00					
11.0400	Concrete Counter Sink Type, with Lever Type Faucet and Complete Accessories	set	2.00					
11.0600	Lavatory, Pedestal Type with Accessories	set	1.00					
11.0500	Faucet, Hose Bibb, Brass 1/2"Ø	pc	25.00					
11.4400	S.S. Grab Rail 1-1/2"Ø	set	5.00					
11.4410	S.S. Floor Drain 4" x 4"	set	16.00					
11.4300	Tissue Holder	pc	5.00					
11.4500	Mirror	sq.ft	24.00					
11.4200	Teflon Tape	roll	6.00					
11.0900	PP-R Pipe 1"Ø x 4.0m	pc	14.00					
11.1000	PP-R Pipe 3/4"Ø x 4.0m	pc	18.00					
11.2000	PP-R Elbow 90° x 1"Ø	pc	6.00					
11.2100	PP-R Elbow 90° x 3/4"Ø	pc	25.00					
11.2600	PP-R Tee, 3/4"Ø	pc	28.00					
11.2900	PP-R Tee Reducer, 1" x 3/4"Ø	pc	3.00					
11.3300	PP-R Plug, 3/4"Ø	pc	14.00					
11.1400	PP-R Coupling, 1"Ø	pc	7.00					
11.1700	PP-R Coupling Reducer, 1" x 3/4"Ø	pc	1.00					
11.3900	Check Valve, Horizontal, 1"Ø	pc	1.00					
11.3700	Gate Valve, 1"Ø	pc	2.00					
11.3800	Gate Valve, 3/4"Ø	pc	5.00					
	<b>Sub-total</b>							
	<b>Rain Water Collector</b>							
	Filter Tank/Rain Water Harvesting Tank							
	1.0m x 1.0m x 1.0m Intermediate Bulk Container (IBC), 1000L Capacity with tube cage and pallet	pc	3.00					
2.0500	Washed Sand	cu.m	0.15					
	Pebbles, 5mm	cu.m	0.10					
	Pebbles, 10mm	cu.m	0.15					
	Granulated Carbon	cu.m	0.15					
2.0300	Crushed Gravel 3/4"	cu.m	0.15					
12.0500	PVC Sanitary Pipe 4"Ø x 3.0m	pc	10.00					
12.0700	PVC Sanitary Pipe 2"Ø x 3.0m	pc	1.00					
	CPVC Pipe 2" dia.	pcs	4.00					
	CPVC Pipe 1" dia.	pcs	4.00					
12.1600	PVC Sanitary Wye 4" x 4"	pc	6.00					
12.2110	PVC Sanitary Tee 4" x 4"	pc	1.00					
12.1300	PVC Sanitary Elbow 1/8 x 4"Ø	pc	6.00					



12.0900	PVC Sanitary Elbow 90° x 4"Ø	pc	10.00					
12.1100	PVC Sanitary Elbow 90° x 2"Ø	pc	7.00					
12.1110	PVC Sanitary Elbow 90° x 1"Ø	pc	2.00					
12.2400	Brass Cleanout 4" x 4"	pc	1.00					
	Gate Valve, 4" dia.	pcs	1.00					
11.3600	Gate Valve, 2"Ø	pc	2.00					
11.3700	Gate Valve, 1"Ø	pc	1.00					
11.3900	Check Valve, Horizontal, 1"Ø	pc	1.00					
12.3000	PVC Cement	can	2.00					
	50mm Vent Screen	pcs	3.00					
	Male adapter wit gasket and nuts	pcs	6.00					
	RWHT Support							
7.0410	L 100 x 100 x 6.0mm	kg	84.00					
7.0810	L 75 x 75 x 6mm	kg	311.69					
7.0710	L 65 x 65 x 6.0mm	kg	86.43					
7.1100	Steel Plate 1.20m x 2.40m x 6mm thk	pc	1.00					
7.3600	Welding Rod	kg	9.64					
13.1100	Primer, Zinc Chromate	gal	3.00					
	Pedestal/Footing	cu.m	0.09					
2.0200	Portland Cement	bag	1.00					
2.0500	Washed Sand	cu.m	0.25					
2.0300	Crushed Gravel 3/4"	cu.m	0.25					
3.1000	D10mm x 6.00 mts RSB	pc	2.00					
3.1100	D12mm x 6.00 mts RSB	pc	1.00					
3.0600	D16mm x 6.00 mts RSB	pc	1.00					
3.1200	G.I. Tie Wire	kg	0.45					
	<b>Sub-Total</b>							
12.0000	<b>Sanitary Works</b>							
12.0110	Three Chamber Septic Vault	unit	1.00					
12.0100	Catch Basin	unit	20.00					
12.2800	Closet Bend, 4"	pc	5.00					
12.0300	Stainless Steel Vent Protection Screen, 2"	pc	1.00					
12.0400	PVC Sanitary Pipe 6"Ø x 3.0m	pc	3.00					
12.0500	PVC Sanitary Pipe 4"Ø x 3.0m	pc	70.00					
12.0700	PVC Sanitary Pipe 2"Ø x 3.0m	pc	21.00					
	PVC Sanitary Pipe 1-1/2"Ø	pc	6.00					
12.1600	PVC Sanitary Wye 4" x 4"	pc	33.00					
	PVC Sanitary Wye 4" x 1-1/2"	pc	7.00					
	PVC Sanitary Wye 1-1/2" x 1-1/2"	pc	7.00					
12.1300	PVC Sanitary Elbow 1/8 x 4"Ø	pc	4.00					
	PVC Sanitary Elbow 1/8 x 1-1/2"Ø	pc	14.00					

12.0900	PVC Sanitary Elbow 90° x 4"Ø	pc	36.00					
12.1100	PVC Sanitary Elbow 90° x 2"Ø	pc	12.00					
12.2100	PVC Sanitary Tee 6" x 6"	pc	3.00					
12.2110	PVC Sanitary Tee 4" x 4"	pc	2.00					
12.2200	PVC Sanitary Tee 2" x 2"	pc	19.00					
12.2600	PVC P-Trap 4"	pc	16.00					
	PVC P-Trap 1-1/2"	pc	7.00					
12.2400	Brass Cleanout 4" x 4"	pc	8.00					
12.2900	Roof Drain	pc	12.00					
12.3000	PVC Cement	can	6.00					
	<b>Sub-total</b>							
13.0000	<b>Painting Works</b>							
	Concrete surfaces	sq.m	758.35					
13.0100	Neutralizer	gal	10.00					
13.0200	Latex, Flat	gal	31.00					
13.0300	Masonry Putty	gal	31.00					
13.0400	Latex, Semi Gloss	gal	31.00					
13.0500	Acri Color	qrt	8.00					
	Wood surfaces	sq.m	385.87					
13.0600	Enamel, Flatwall	gal	20.00					
13.0700	Glazing Putty	gal	20.00					
13.0800	Enamel, Semi Gloss	gal	20.00					
13.0900	Paint Thinner	gal	10.00					
	Steel Surfaces							
13.1100	Primer, Zinc Chromate	gal	2.00					
	<b>Sub-total</b>							
15.0000	<b>Waterproofing</b>							
15.0100	Waterproofing, Cementitious	gal	35.00					
	<b>Sub-total</b>							
14.0000	<b>Tile Works</b>							
	Toilet (Wall)	sq.m	45.53					
14.0110	Glazed Wall Tiles 20cm x 20cm	pc	1,196.00					
14.0300	Tile Adhesive 25 kg/bag	bag	9.00					
14.0400	Tile Trim 6mm	pc	17.00					
14.0500	Tile Grout 5 kg/bag	bag	4.00					
	Toilet (Flooring)	sq.m	22.64					
	Unglazed Floor Tiles 30cm x 30cm	pc	265.00					
14.0300	Tile Adhesive 25 kg/bag	bag	5.00					
14.0500	Tile Grout 5 kg/bag	bag	2.00					
	Handwashing Sink	sq.m	13.88					
14.0110	Glazed Wall Tiles 20cm x 20cm	pc	365.00					
14.0300	Tile Adhesive 25 kg/bag	bag	3.00					
14.0400	Tile Trim 6mm	pc	13.00					
14.0500	Tile Grout 5 kg/bag	bag	2.00					
	Concrete Platform	sq.m	11.20					
	Unglazed Floor Tiles 30cm x 30cm	pc	131.00					

14.0300	Tile Adhesive 25 kg/bag	bag	3.00					
14.0500	Tile Grout 5 kg/bag	bag	1.00					
	<b>Sub-total</b>							
<b>I.</b>	<b>DIRECT COST</b>							
<b>II.</b>	<b>INDIRECT COST 17% of (I - General Req.)</b>							
<b>III.</b>	<b>TAX 5% of (I + II)</b>							
<b>IV.</b>	<b>TOTAL CONSTRUCTION COST (I + II + III)</b>							

Prepared by:

---

Contractor's Authorized Representative Name & Signature

This procuring entity (PE) will adopt to the Department of Public Works and Highways' (DPWH Blue Book) Standard Specifications for Public Works Structures. On this regard, PE is requiring the contractor's Materials Engineer to prepare detailed Quality Control Program (QCP) to wit:

<b>ITEM NO.</b>	<b>DESCRIPTION</b>	<b>REQUIRED TEST</b>
	<b>GENERAL REQUIREMENTS</b>	<b>IR</b>
<i>CONSTRUCTION OF ONE (1) STOREY - TWO (2) CLASSROOMS SCHOOL BUILDING (WITH COMMON TOILET)</i>		
1.0000	Earthworks	FDT C P G GCA IR
2.0000	Concreting Works (3000 psi)	CCS DM QT GCA GFA IR
3.0000	Rebars Works	QT IR
4.0000	Formworks	IR
5.0000	Masonry Works	QT GFA IR
6.0000	Doors and Windows	IR
7.0000	Steel Works	QT IR
8.0000	Roofing Works	QT
9.0000	Ceiling and Carpentry Works	QT IR
10.0000	Electrical Works	IR
11.0000	Plumbing Works	QT IR
	Rain Water Collector	IR
12.0000	Sanitary Works	QT IR
13.0000	Painting Works	QT IR
15.0000	Waterproofing	IR
14.0000	Tile Works	IR
<i>MANJUYOD CES - SPED CENTER</i>		
<i>CONSTRUCTION OF ONE (1) STOREY - THREE (3) CLASSROOMS SCHOOL BUILDING (WITH COMMON TOILET)</i>		
1.0000	Earthworks	FDT C P G GCA

		IR
2.0000	Concreting Works (3000 psi)	CCS DM QT GCA GFA IR
3.0000	Rebars Works	QT IR
4.0000	Formworks	IR
5.0000	Masonry Works	QT GFA IR
6.0000	Doors and Windows	IR
7.0000	Steel Works	QT IR
8.0000	Roofing Works	QT
9.0000	Ceiling and Carpentry Works	QT IR
10.0000	Electrical Works	IR
11.0000	Plumbing Works	QT IR
	Rain Water Collector	IR
12.0000	Sanitary Works	QT IR
13.0000	Painting Works	QT IR
15.0000	Waterproofing	IR
14.0000	Tile Works	IR

LEGEND:	IR	Inspection Report	GCA	Grading on Coarse Aggregates
	FDT	Field Density Test	GFA	Grading on Fine Aggregates
	C	Compaction	CCS	Concrete Cylinder Sample
	P	Plasticity	DM	Design Mix
	G	Grading	QT	Quality Test

The minimum number of test to be performed must be based on the DPWH Blue Book - Standard Specifications for Public Works Structures (the latest volume). All test must yield passing result.

The detailed Quality Control Program (QCP) must be:

1. Signed as Prepared by the contractor's Materials Engineer;
2. Signed as conforme by the contractor;
3. Signed as reviewed by the DepEd, Division Engineer;
4. Signed for recommending approval by DepEd, SGOD Chief ;
5. Signed as approved by the DepEd, Schools Division of Negros Oriental.

Furthermore, QCP must be typed or written in ink, and shall bear the following:

1. Contractor's Logo / Header;
2. Contract Identification Number;

3. Name of the Project;
4. Location of the Project;
5. Contract Price;
6. Date received of NTP;
7. Contract Duration (in Calendar Days); and
8. Test Results / Certificates as supporting documents.

## ***Section VII. Drawings***

*Prospective bidders will be provided with an electronic copy of the plans upon purchase of this bidding document.*

# ARCHITECTURAL PLAN

(One (1) Storey Two (2) Classrooms School Building with Toilet)







NOTE:  
 1. ALL DIMENSIONS ARE IN METERS UNLESS OTHERWISE NOTED.  
 2. ALL DIMENSIONS ARE TO FACE UNLESS OTHERWISE NOTED.  
 3. ALL DIMENSIONS ARE TO CENTERLINE UNLESS OTHERWISE NOTED.  
 4. ALL DIMENSIONS ARE TO THE OUTSIDE UNLESS OTHERWISE NOTED.  
 5. ALL DIMENSIONS ARE TO THE INSIDE UNLESS OTHERWISE NOTED.  
 6. ALL DIMENSIONS ARE TO THE CENTERLINE UNLESS OTHERWISE NOTED.  
 7. ALL DIMENSIONS ARE TO THE FACE UNLESS OTHERWISE NOTED.

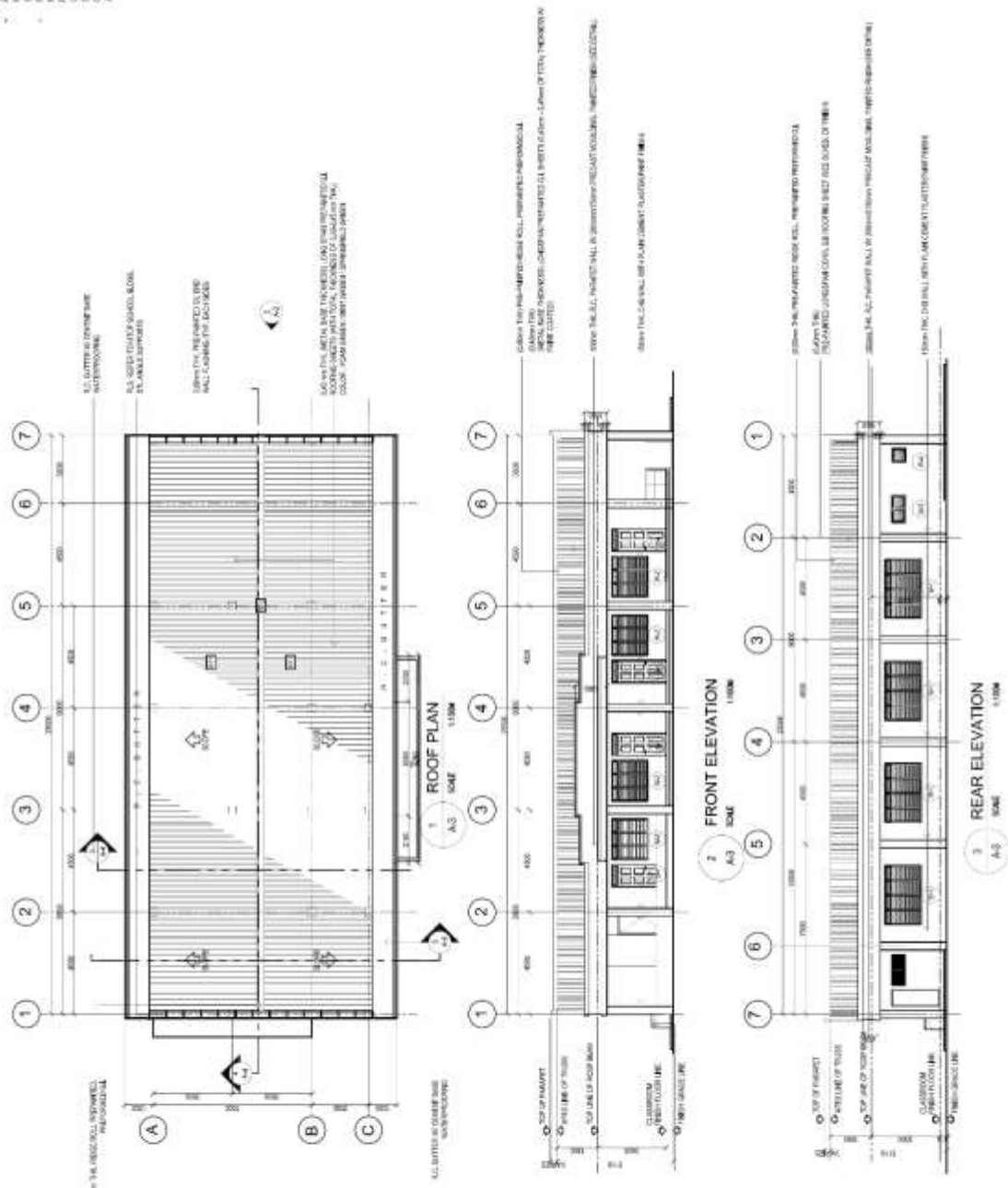

 REPUBLIC OF THE PHILIPPINES <b>DepEd</b> DEPARTMENT OF EDUCATION REGIONAL OFFICE - CALABARZON DIVISION OFFICE - CALABARZON	SHEET NO.: <b>A-3</b> 7
	PROJECT NAME: <b>DEPARTMENT OF EDUCATION          DepEd</b>
PROJECT NO.: <b>ONE (1) STOREY TWO (2) CLASSROOM          SCHOOL BUILDING          (WITH COMMON TOILETS &amp; ONE ROOM)</b>	SHEET NO.: <b>A-3</b> 7
ARCHITECT: <b>ANDREW T. OSILADO</b> ARCHITECT	PROJECT NO.: <b>ONE (1) STOREY TWO (2) CLASSROOM          SCHOOL BUILDING          (WITH COMMON TOILETS &amp; ONE ROOM)</b>
ENGINEER: <b>ANDREW T. OSILADO</b> ARCHITECT	PROJECT NO.: <b>ONE (1) STOREY TWO (2) CLASSROOM          SCHOOL BUILDING          (WITH COMMON TOILETS &amp; ONE ROOM)</b>
ARCHITECT: <b>ANDREW T. OSILADO</b> ARCHITECT	PROJECT NO.: <b>ONE (1) STOREY TWO (2) CLASSROOM          SCHOOL BUILDING          (WITH COMMON TOILETS &amp; ONE ROOM)</b>
ARCHITECT: <b>ANDREW T. OSILADO</b> ARCHITECT	PROJECT NO.: <b>ONE (1) STOREY TWO (2) CLASSROOM          SCHOOL BUILDING          (WITH COMMON TOILETS &amp; ONE ROOM)</b>
ARCHITECT: <b>ANDREW T. OSILADO</b> ARCHITECT	PROJECT NO.: <b>ONE (1) STOREY TWO (2) CLASSROOM          SCHOOL BUILDING          (WITH COMMON TOILETS &amp; ONE ROOM)</b>
ARCHITECT: <b>ANDREW T. OSILADO</b> ARCHITECT	PROJECT NO.: <b>ONE (1) STOREY TWO (2) CLASSROOM          SCHOOL BUILDING          (WITH COMMON TOILETS &amp; ONE ROOM)</b>
ARCHITECT: <b>ANDREW T. OSILADO</b> ARCHITECT	PROJECT NO.: <b>ONE (1) STOREY TWO (2) CLASSROOM          SCHOOL BUILDING          (WITH COMMON TOILETS &amp; ONE ROOM)</b>

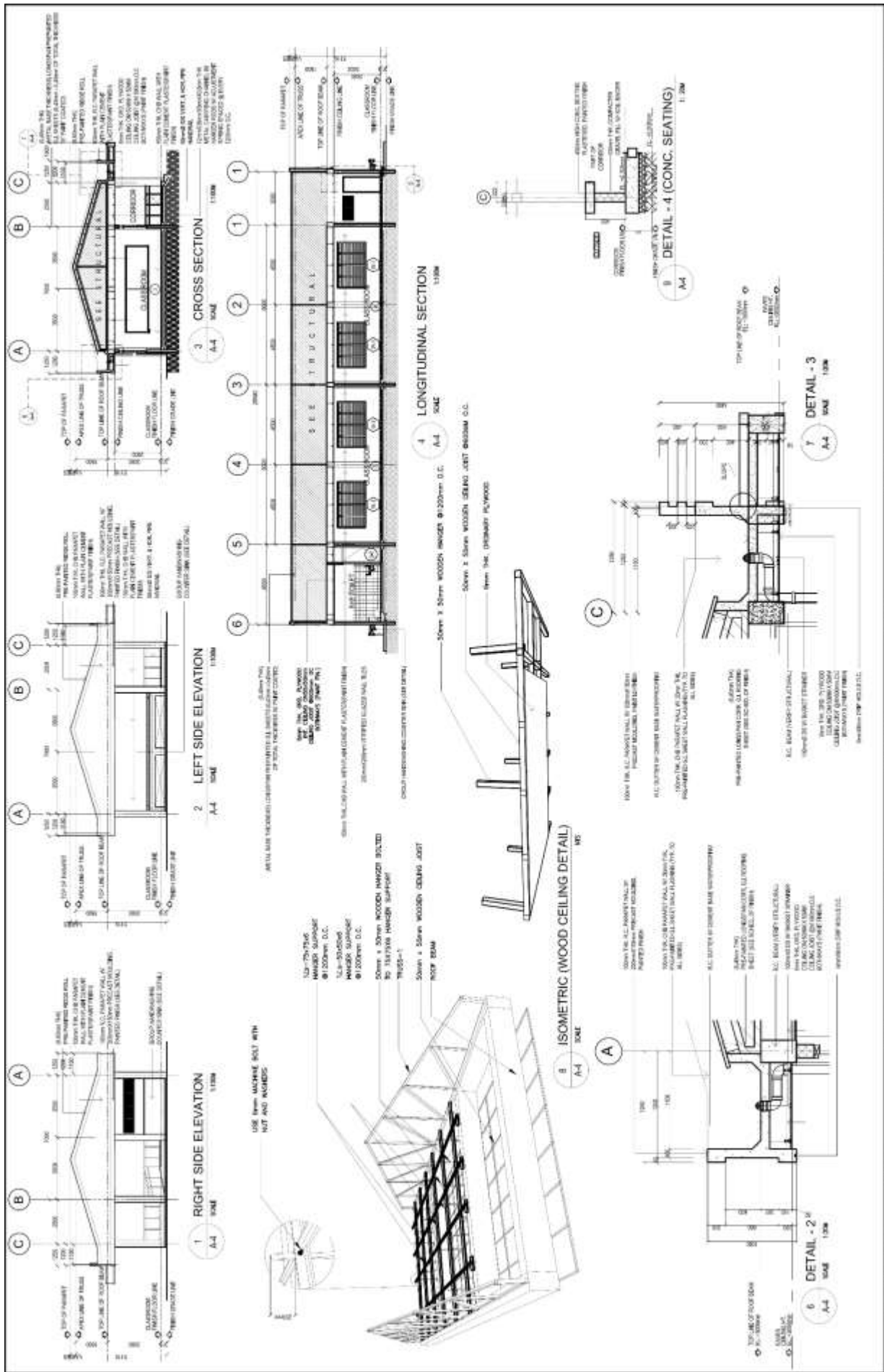

<p>DEPARTMENT OF EDUCATION DepEd</p>	<p>PROJECT NO: A-4 7</p>
<p>PROJECT TITLE: BROWN-FRAMED WOODEN CLASSROOM WITH WOODEN SEATING (WITH COMMON TOILETS ON SIDE)</p>	<p>DESIGNED BY: ALAN DEL S. PANGRA ARCHITECTURE FOR AMBASSADORS</p>
<p>DESIGNED BY: ARQUITECTO PANGRA</p>	<p>DESIGNED BY: LUIS C. FERREIRA, JR. ARCHITECT FOR AMBASSADORS</p>
<p>DESIGNED BY: ATYAPANGRA S. NARMO ARCHITECT FOR AMBASSADORS</p>	<p>DESIGNED BY: ANDREW P. CELADO ARCHITECT FOR AMBASSADORS</p>
<p>DESIGNED BY: DepEd</p>	<p>DESIGNED BY: DepEd</p>



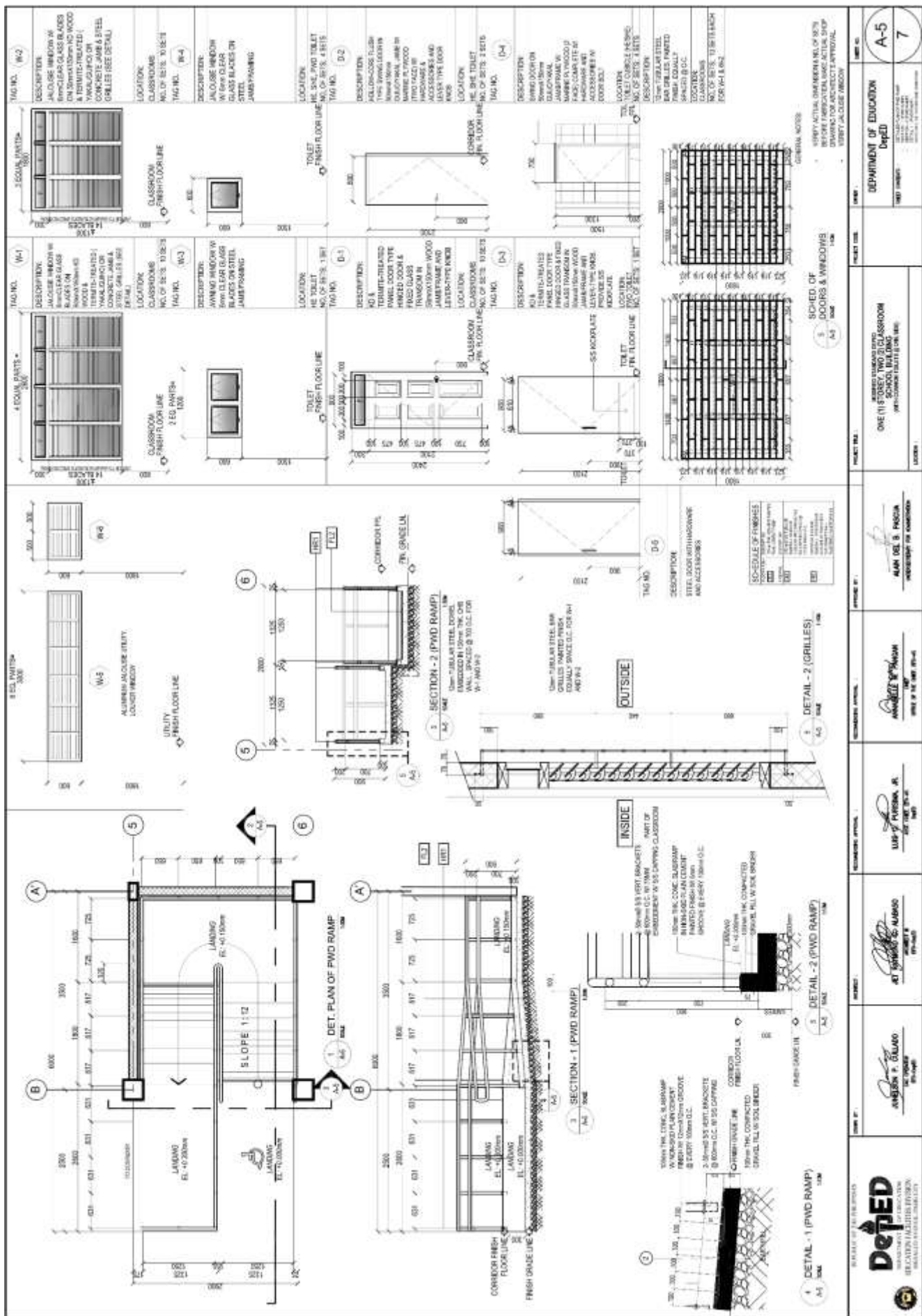

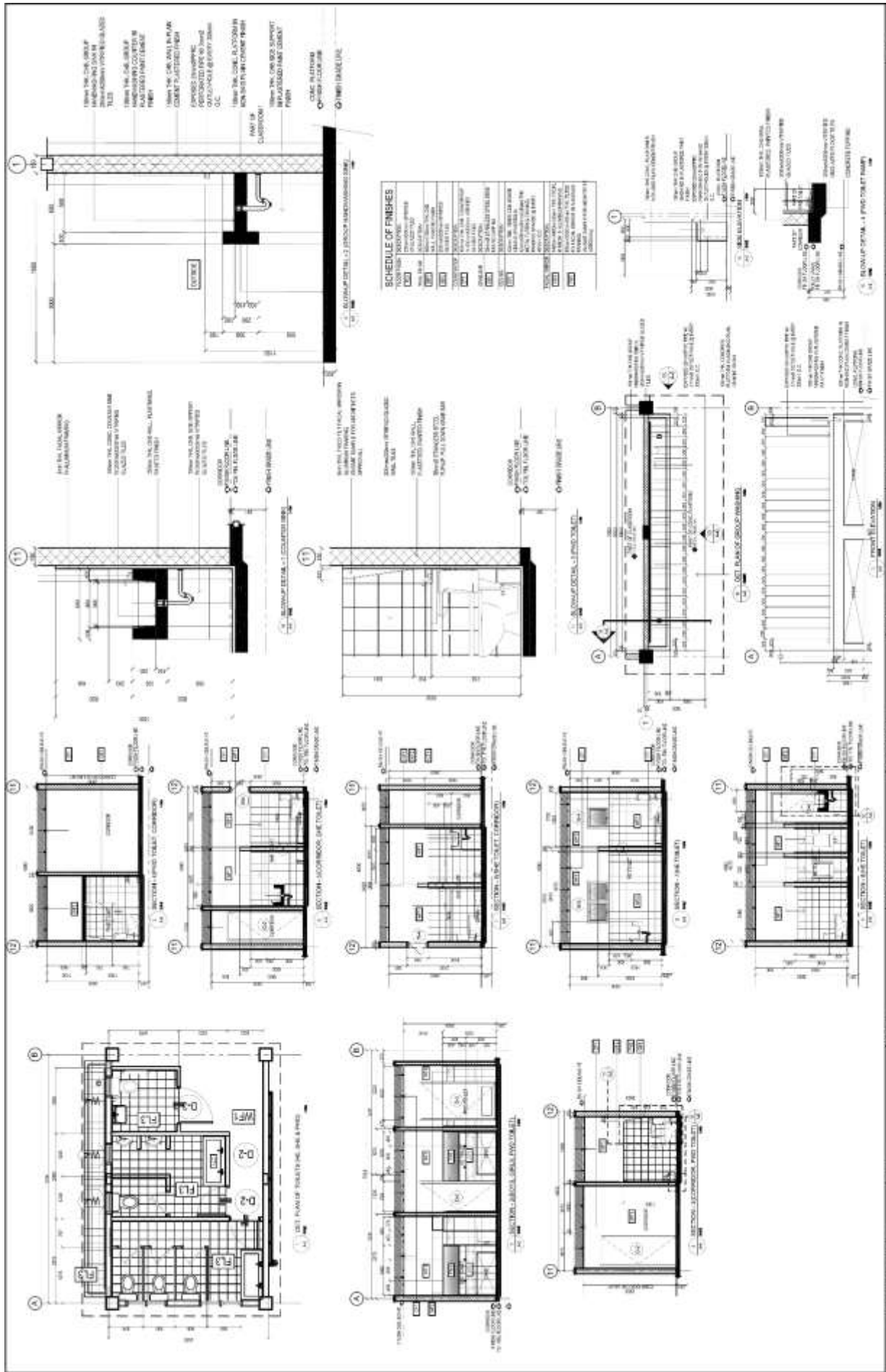

**DEPED**  
 DEPARTMENT OF EDUCATION  
 DepEd  
 DIVISION OFFICE - CAGAYAN DE ORO  
 REGIONAL OFFICE - CAGAYAN DE ORO  
 PROJECT TITLE: **NUMBER TWO (2) CLASSROOM ONE (1) STOREY TWO (2) CLASSROOM SCHOOL BUILDING (WITH COMMON TOILETS) (ONE BLDG)**  
 PROJECT NO.: **101-102-103-104-105-106-107-108-109-110-111-112-113-114-115-116-117-118-119-120-121-122-123-124-125-126-127-128-129-130-131-132-133-134-135-136-137-138-139-140-141-142-143-144-145-146-147-148-149-150-151-152-153-154-155-156-157-158-159-160-161-162-163-164-165-166-167-168-169-170-171-172-173-174-175-176-177-178-179-180-181-182-183-184-185-186-187-188-189-190-191-192-193-194-195-196-197-198-199-200**  
 SHEET NO.: **A-6**  
 OF **7**  
 DATE: **2018-08-01**  
 DRAWN BY: **ALAN DE B. PRODA**  
 CHECKED BY: **ANGELICA M. MORALES**  
 APPROVED BY: **ANGELICA M. MORALES**  
 TITLE: **NO. 101-102-103-104-105-106-107-108-109-110-111-112-113-114-115-116-117-118-119-120-121-122-123-124-125-126-127-128-129-130-131-132-133-134-135-136-137-138-139-140-141-142-143-144-145-146-147-148-149-150-151-152-153-154-155-156-157-158-159-160-161-162-163-164-165-166-167-168-169-170-171-172-173-174-175-176-177-178-179-180-181-182-183-184-185-186-187-188-189-190-191-192-193-194-195-196-197-198-199-200**  
 PROJECT NO.: **101-102-103-104-105-106-107-108-109-110-111-112-113-114-115-116-117-118-119-120-121-122-123-124-125-126-127-128-129-130-131-132-133-134-135-136-137-138-139-140-141-142-143-144-145-146-147-148-149-150-151-152-153-154-155-156-157-158-159-160-161-162-163-164-165-166-167-168-169-170-171-172-173-174-175-176-177-178-179-180-181-182-183-184-185-186-187-188-189-190-191-192-193-194-195-196-197-198-199-200**  
 SHEET NO.: **A-6**  
 OF **7**  
 DATE: **2018-08-01**  
 DRAWN BY: **ALAN DE B. PRODA**  
 CHECKED BY: **ANGELICA M. MORALES**  
 APPROVED BY: **ANGELICA M. MORALES**  
 TITLE: **NO. 101-102-103-104-105-106-107-108-109-110-111-112-113-114-115-116-117-118-119-120-121-122-123-124-125-126-127-128-129-130-131-132-133-134-135-136-137-138-139-140-141-142-143-144-145-146-147-148-149-150-151-152-153-154-155-156-157-158-159-160-161-162-163-164-165-166-167-168-169-170-171-172-173-174-175-176-177-178-179-180-181-182-183-184-185-186-187-188-189-190-191-192-193-194-195-196-197-198-199-200**

# STRUCTURAL PLAN

(One (1) Storey Two (2) Classrooms School Building with Toilet)

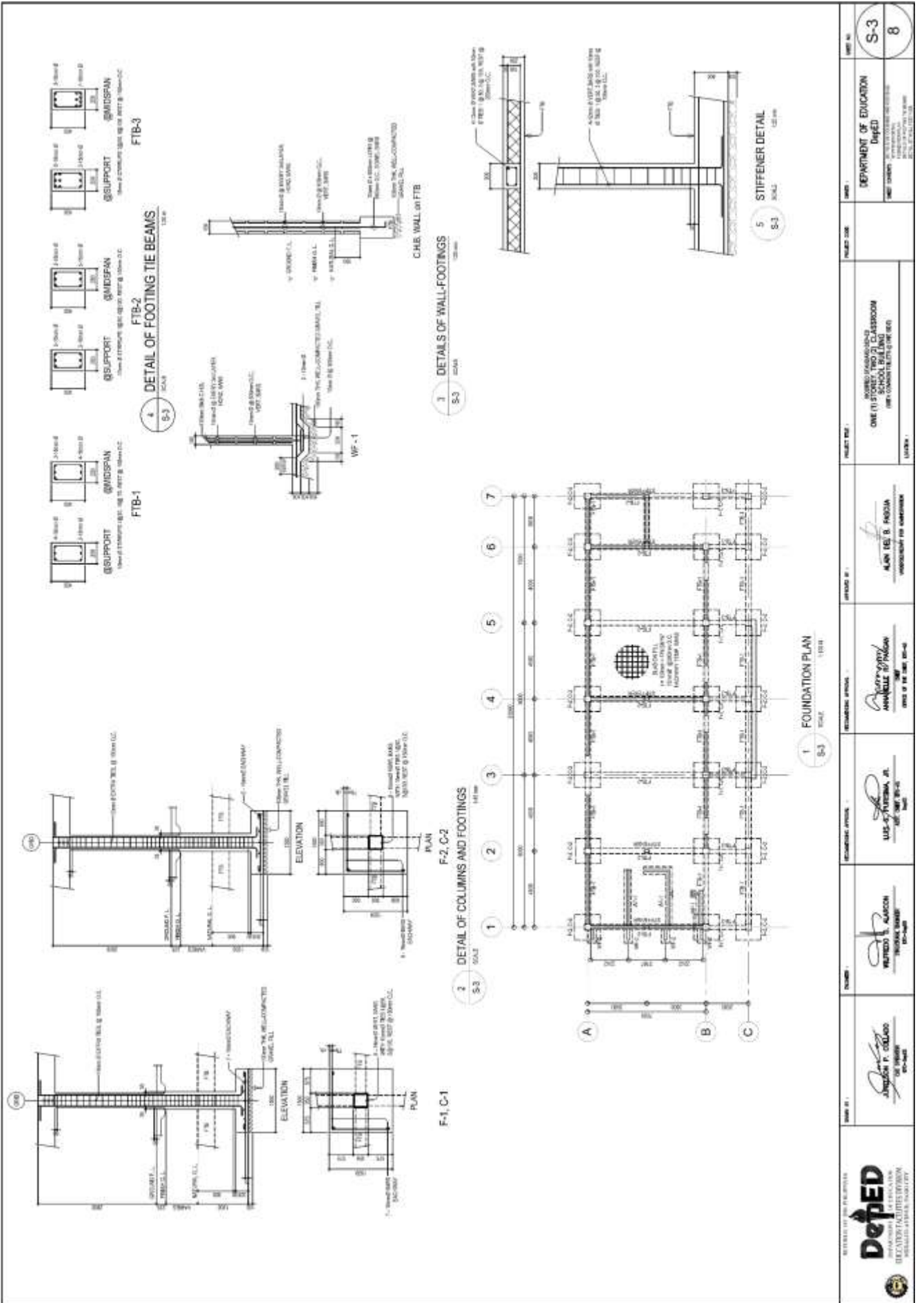

	<b>DEPED</b> DIVISION OFFICE MARIKINA CITY	<b>DESIGNED BY:</b> JACOBSON P. DELA CRUZ CIVIL ENGINEER	<b>CHECKED BY:</b> WALTER T. JACOBSON CIVIL ENGINEER	<b>REVISIONS:</b> NONE	<b>APPROVED BY:</b>  ALAN DEL B. PACIONA PROFESSIONAL CIVIL ENGINEER	<b>PROJECT TITLE:</b> MARICINA ELEMENTARY SCHOOL BUILDING (NEW CONSTRUCTION OF THE BLDG)	<b>PROJECT CODE:</b> 	<b>DATE:</b> 	<b>SCALE:</b> 
									<b>PROJECT NO.:</b> 
<b>DEPARTMENT OF EDUCATION</b> <b>DepEd</b>									
<b>S-3</b> <b>8</b>									



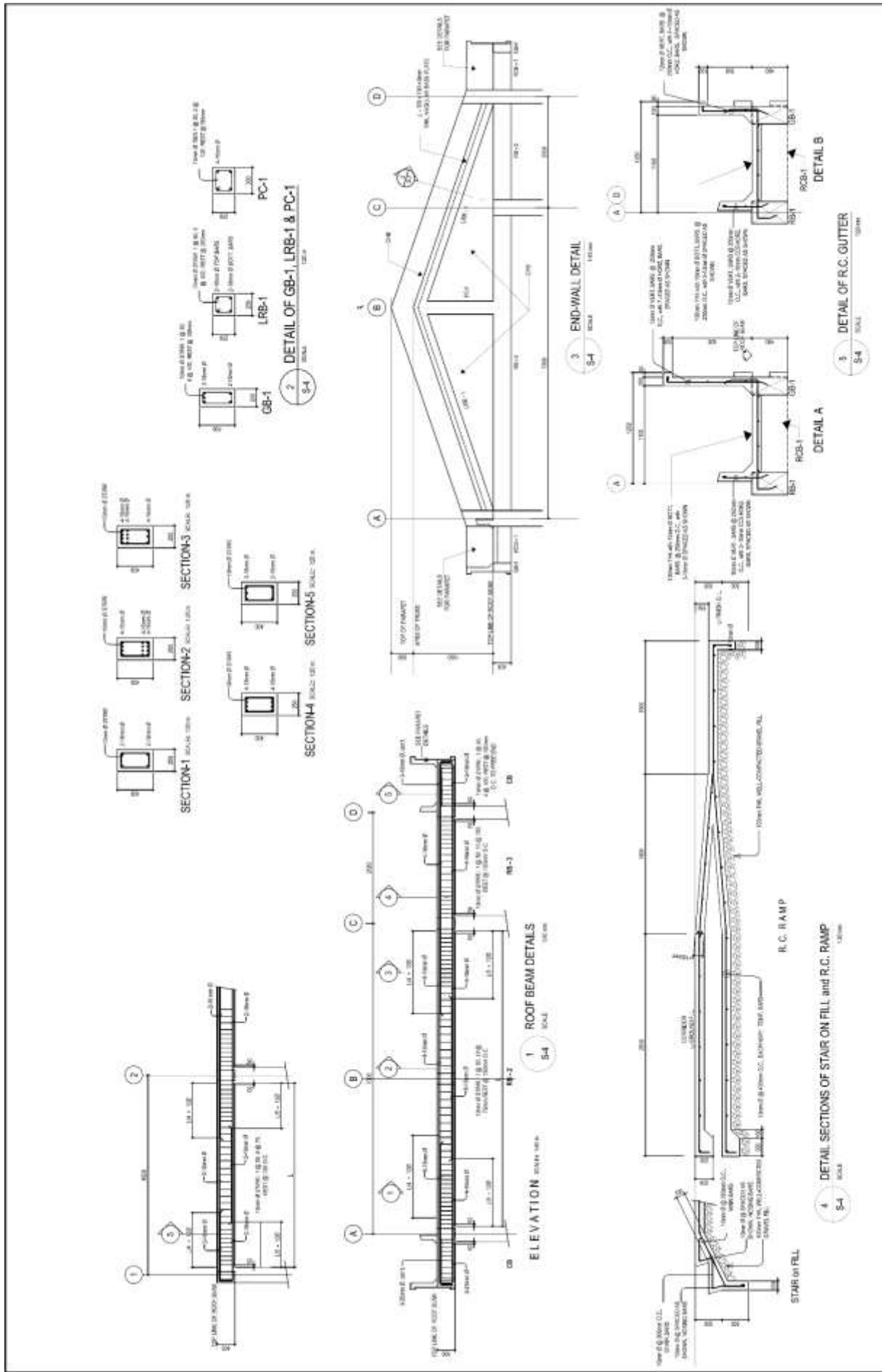

 DEPARTMENT OF EDUCATION DIVISION OFFICE - CALABARZON DIVISION OFFICE - CALABARZON DIVISION OFFICE - CALABARZON	WORK NO. 1  JUAN P. CALADO ARCHITECT 02-1000	WORKING DRAWING NO. 7  LUIS ALFONSO ARCHITECT 02-1000	WORKING DRAWING NO. 8  ANABELLE B. PANGILINAN ARCHITECT 02-1000	PROJECT NO. 1 NAME OF PROJECT ONE (1) STORIES TYPICAL CLASSROOM SCHOOL BUILDING (WITH COMMON TOILETS & SHOWER)	PROJECT CODE DEPARTMENT OF EDUCATION DepEd	SHEET NO. S-4 8
	SHEET NO. 1  JUAN P. CALADO ARCHITECT 02-1000	SHEET NO. 2  LUIS ALFONSO ARCHITECT 02-1000	SHEET NO. 3  ANABELLE B. PANGILINAN ARCHITECT 02-1000	SHEET NO. 4  ANABELLE B. PANGILINAN ARCHITECT 02-1000	SHEET NO. 5  ANABELLE B. PANGILINAN ARCHITECT 02-1000	SHEET NO. 6  ANABELLE B. PANGILINAN ARCHITECT 02-1000

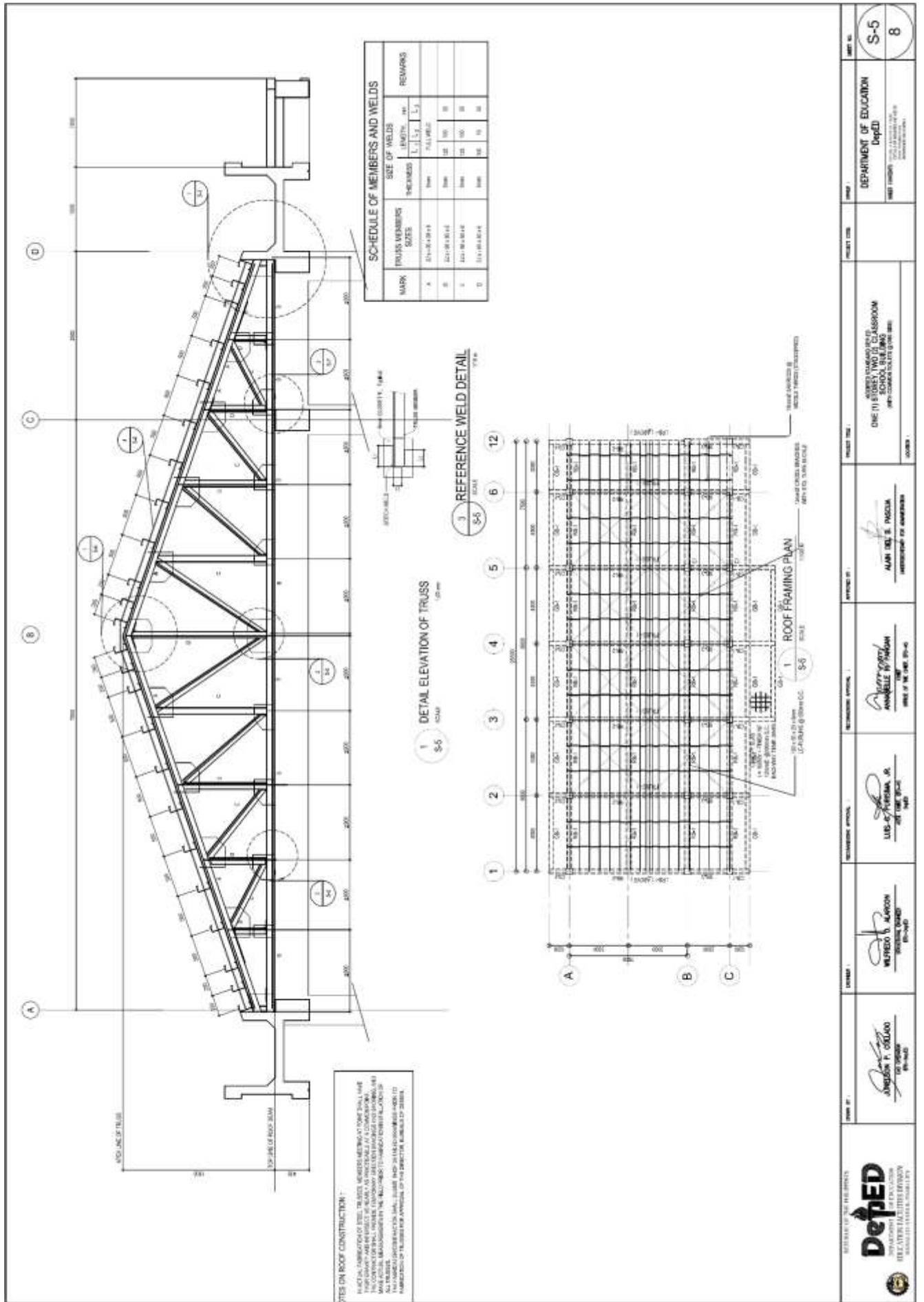

**DEPED**  
DEPARTMENT OF EDUCATION  
DIVISION OFFICE - CALABANG

**PROJECT TITLE:** ROOF FRAMING PLAN

**PROJECT CODE:** DEPED - CALABANG - 2024 - 001

**PROJECT NO.:** S-5

**REV. NO.:** 8

**DESIGNED BY:** JUAN CARLOS B. ALONSO  
PROJECT ENGINEER

**CHECKED BY:** ALAN DELA CRUZ  
SUPERVISOR OF ARCHITECTURE

**APPROVED BY:** ANABELLE N. FERRER  
SUPERVISOR OF ARCHITECTURE

**DATE:** 2024-09-10

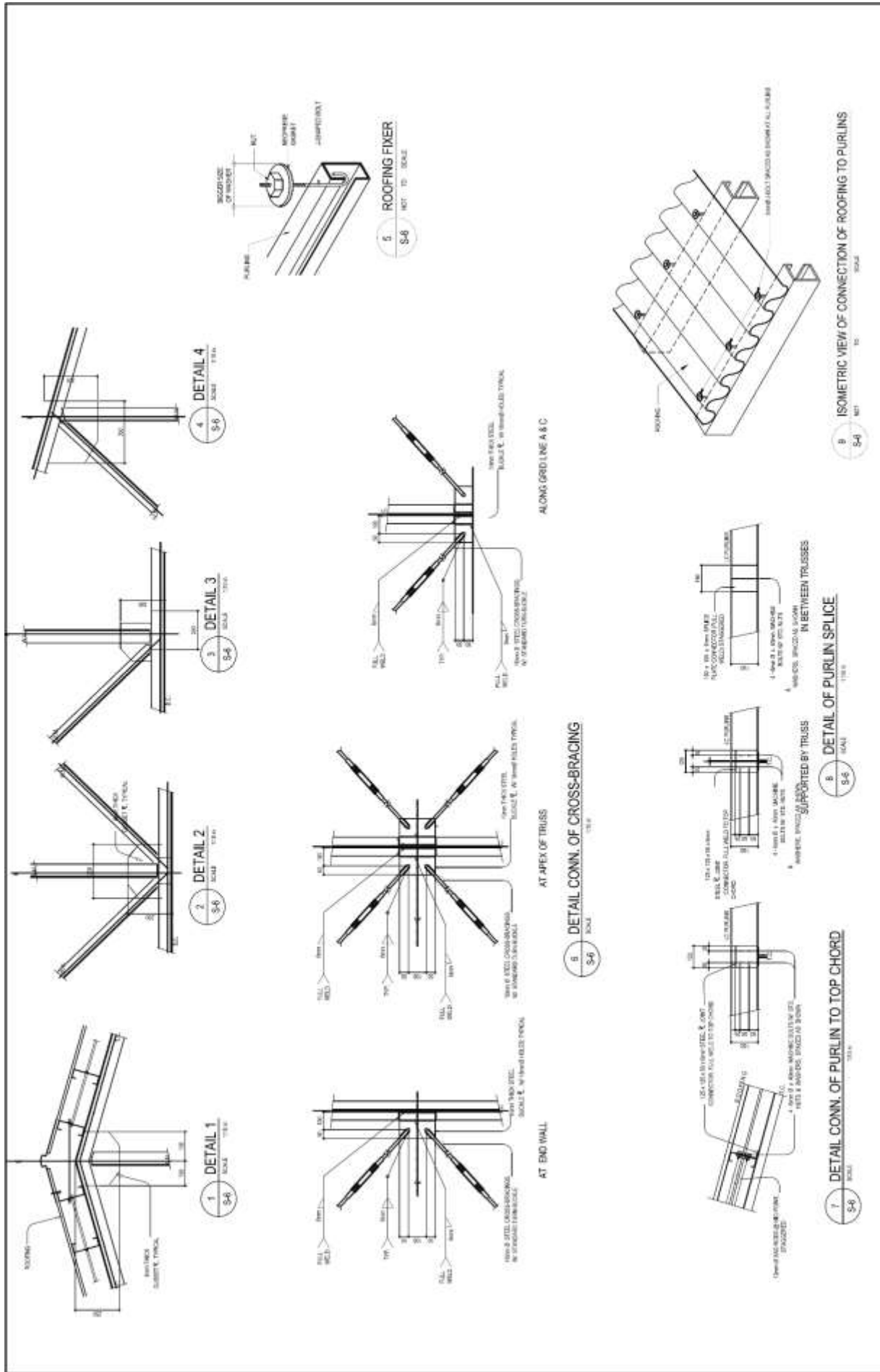

 DEPARTMENT OF EDUCATION DIRECTOR FACILITIES 1000 UNIVERSITY AVENUE TOLSON, MISSOURI 64501	DRAWN BY:  JACKSON F. O'LEARY ARCHITECT	CHECKED BY:  VINCENT J. ALAGONA ARCHITECT	APPROVED BY:  ALAN DEL. ILACQUA ARCHITECTURAL ENGINEER	PROJECT FILE: ONE (1) STOREY, TWO (2) CLASSROOM WITH COMPUTER LABS ONE UNIT	SHEET NO: S-6 8
	DEPARTMENT OF EDUCATION Dept.ED NET WEIGHT: 1.20 (2025) GROSS WEIGHT: 1.20 (2025) DATE: 2025-03-20			LOCKED	





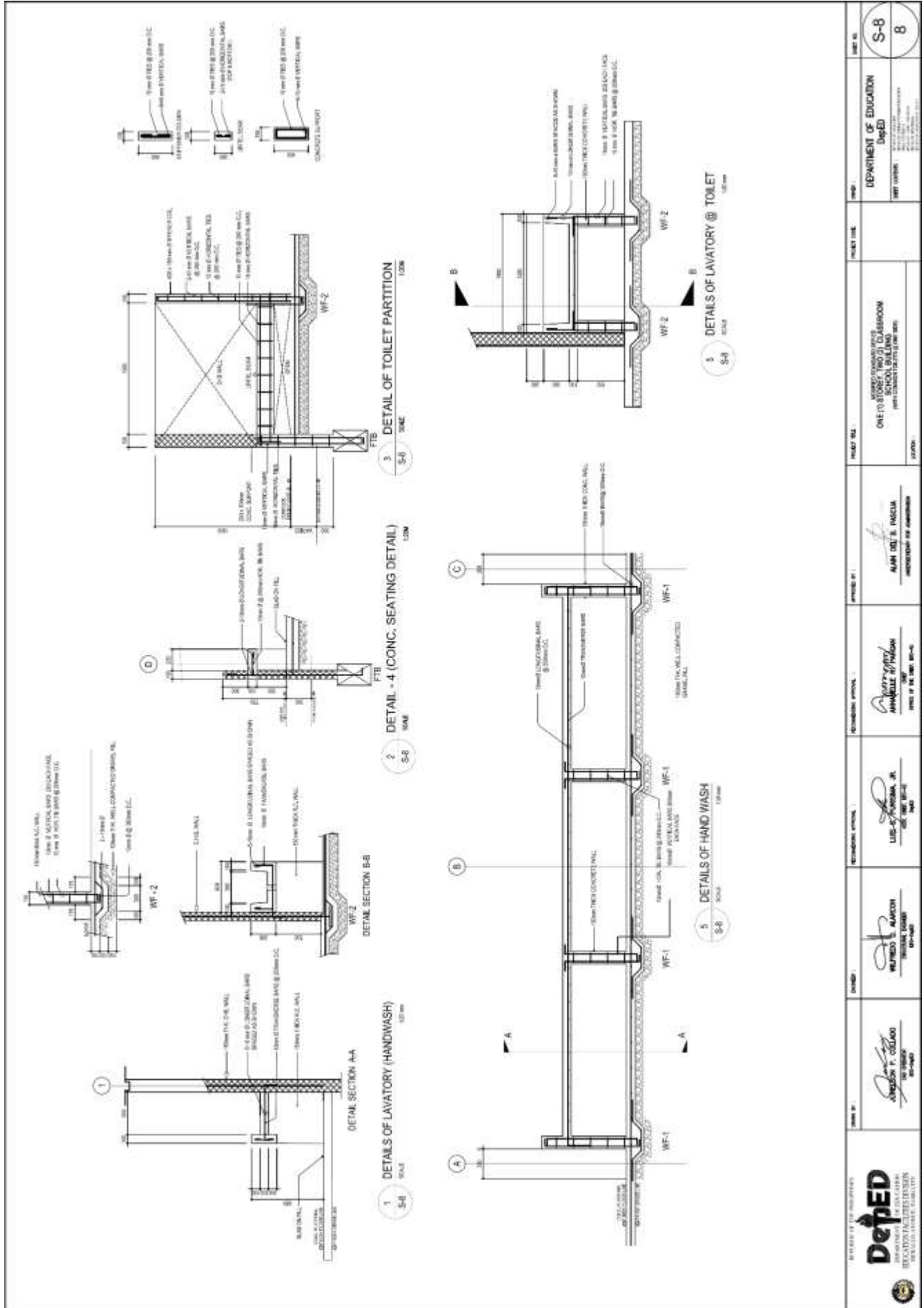

 DIVISION OFFICE - CALABANG <b>DepEd</b> DIVISION OFFICE - CALABANG EDUCATION SERVICES DIVISION DIVISION OFFICE - CALABANG	DRAWN BY: <b>JANSELINO T. COLADO</b> ARCHITECT 01-1440	CHECKED BY: <b>RUFINO S. ALARCON</b> SENIOR ARCHITECT 01-1440	REVISIONS: <b>LIZA A. ARANA, JR.</b> ARCHITECT 01-1440	CONSULTING ARCHITECT: <b>ANABELLE M. PAGAN</b> ARCHITECT 01-1440	PROJECT ARCHITECT: <b>ALVIN D. S. PASCUA</b> ARCHITECT FOR CONSULTING	PROJECT TITLE: <b>WORKED DRAWINGS FOR ONE (1) STOREY TWO (2) CLASSROOM WITH LAVATORY AND TOILET</b>	SHEET NO: <b>S-8</b> 8
---	---	--	---	---	---	---	---------------------------







# ELECTRICAL PLAN

(One (1) Storey Two (2) Classrooms School Building with Toilet)



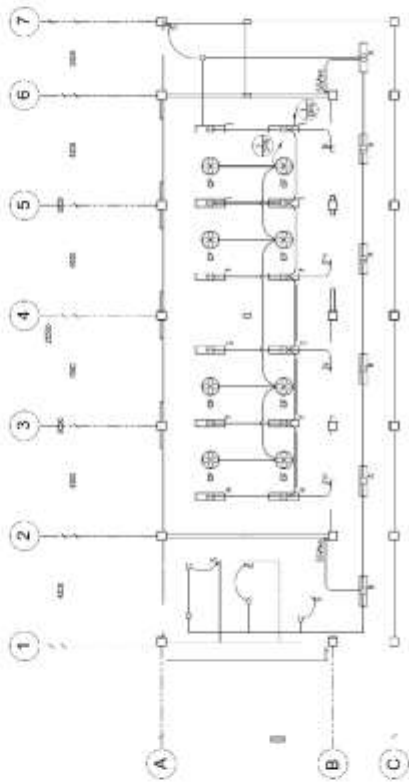
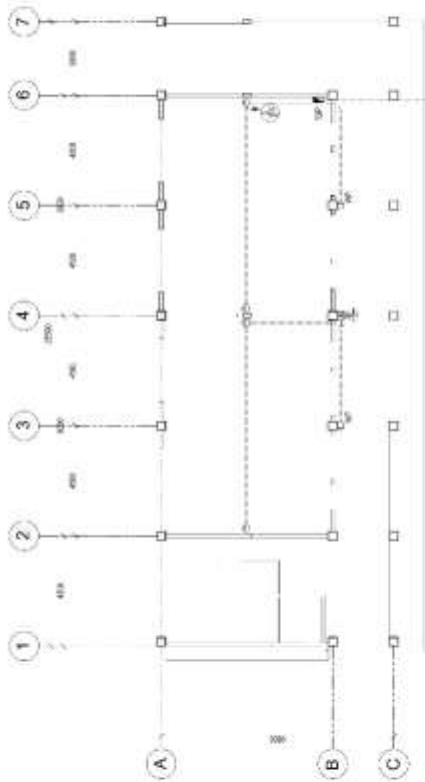

 DELPED DEPARTMENT OF EDUCATION DELAWARE DEPARTMENT OF EDUCATION DEPARTMENT OF EDUCATION DEPARTMENT OF EDUCATION	ANGEL C. BILVA PROJECT MANAGER 03/20/2021	FELIX A. MORALES ELECTRICAL ENGINEER 03/20/2021	LUCAS J. PERAZA ELECTRICAL ENGINEER 03/20/2021	ANTHONY J. ANTONIO ELECTRICAL ENGINEER 03/20/2021	ANA DEL E. PACHECO ELECTRICAL ENGINEER 03/20/2021	PROJECT TITLE: <b>ONE (1) STORY, TWO (2) CLASSROOM</b> NEW CONSTRUCTION (10000)	PROJECT CODE: DEPARTMENT OF EDUCATION DEPARTMENT OF EDUCATION DEPARTMENT OF EDUCATION DEPARTMENT OF EDUCATION	SHEET NO. <b>E-1</b> 2
	SHEET NO. <b>E-1</b> 2	PROJECT TITLE: <b>ONE (1) STORY, TWO (2) CLASSROOM</b> NEW CONSTRUCTION (10000)	PROJECT CODE: DEPARTMENT OF EDUCATION DEPARTMENT OF EDUCATION DEPARTMENT OF EDUCATION DEPARTMENT OF EDUCATION	SHEET NO. <b>E-1</b> 2				



# PLUMBING PLAN

(One (1) Storey Two (2) Classrooms School Building with Toilet)

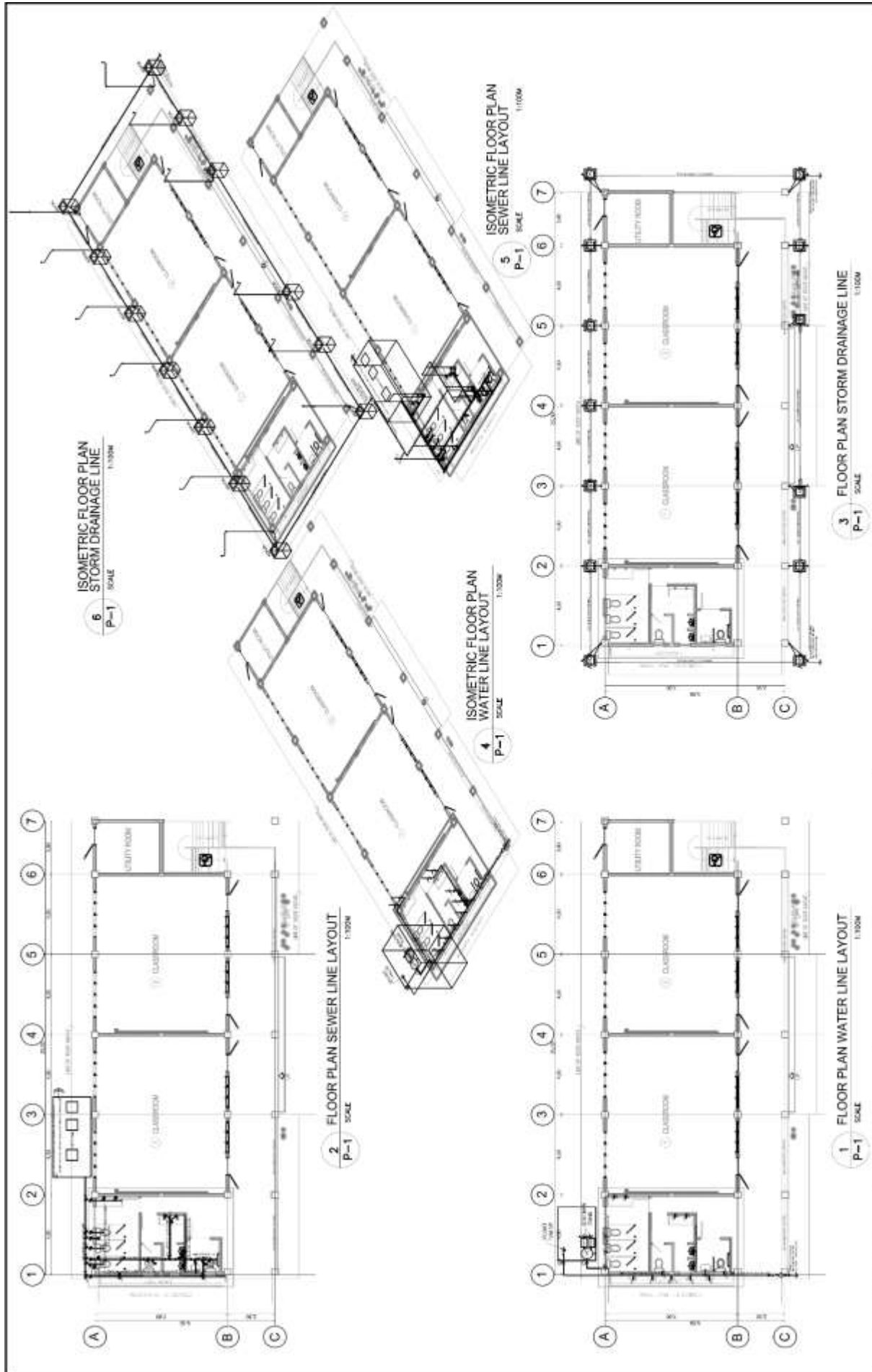

	DESIGNER JAMES P. OLLADO DEPT. ENGINEER DIVISION OFFICE	CHECKER LUIS S. JURADO, JR. DEPT. ENGINEER DIVISION OFFICE	SUPERVISOR ANABELLE P. PANGRA DEPT. ENGINEER DIVISION OFFICE	PROJECT FILE # ALAN DEL S. PADUA ARCHITECTURE FOR AMBASSADORS	PROJECT TITLE NORTHERN MARIKINA (HEAD) SCHOOL BUILDING (WITH COMMON TOILETS @ ONE SIDE)	PROJECT NO. DEPARTMENT OF EDUCATION Divided	SHEET NO. P-1 2
	DIVISION OFFICE - MARIKINA CITY DEPARTMENT OF EDUCATION DIVISION OFFICE - MARIKINA CITY DIVISION OFFICE - MARIKINA CITY						

**GENERAL NOTES:**

1. ALL PLUMBING WORKS INCLUDING HANGERS SHALL BE CHECKED ACCORDING TO THE HANGING PLUMBING CODE, THE NATIONAL BUILDING CODE, AND THE RULES AND REGULATIONS OF THE LOCAL GOVERNMENT AUTHORITIES CONCERNED.
2. COORDINATE THE DRAWING WITH OTHER RELATED DRAWINGS AND SPECIFICATIONS. THE DESIGNER SHALL BE NOTIFIED IMMEDIATELY OF ANY DISCREPANCY FOUND.
3. ALL PIPES SHALL BE INSTALLED AS INDICATED ON PLANS. ANY RELOCATIONS AND/OR ADDITIONS FOR HANGING CONDITIONS OF OTHER TRADES SHALL BE WITH PERMITS AND APPROVAL OF THE ARCHITECT OR ENGINEER.
4. ROOFING UTILITIES SHALL CORRESPOND TO THE ACTUAL LOCATION, LOCATION, DEPTH AND INVERT ELEVATION OF ALL EXISTING PIPES AND STRUCTURES AS NOTED BY THE CONTRACTOR.
5. ALL SUPERS FOR HORIZONTAL DRAINAGES SHALL MAINTAIN AN 8% MINIMUM SLOPE TO THE OUTLET.
6. ALL FITTINGS SHALL BE WRITEL, UNLESS OTHERWISE INDICATED.
7. ALL CHAMBERS, ALL INDIVIDUAL BRANCHES TO THE SERVICE OF GROUPS OF ROOMS AND/OR EQUIPMENT SHALL BE PROVIDED WITH AN CHAMBER OF CAPED OPTICAL FIRE RESISTANCE OF 120 MINUTES AS SHOWN IN THE DETAILS.
8. ALL COVER LIDS SHALL BE PVC GRENZ 1300, "MELT-EX", "SMOOTHED EDGES" OR APPROVED EQUAL.
9. ALL VENT STACK AND VENT SHALL BE PVC GRENZ 2000, "MELT-EX", "SMOOTHED EDGES" OR APPROVED EQUAL.
10. ALL UNWANTED HANGING PIPES AND UNDESIRABLE AND WITH SMOOT CONTACT WITH THE SOIL SHALL BE PROVIDED WITH THE THREE PRETECTIVE TUBES CONFORMING TO THE SANS 1041 WITH BRUSH.
11. WHEN WATER DISTRIBUTION LINES SHALL BE LOCATED IN HANGING, ALL OTHER PIPES TO BE Laid SHALL BE AS PER SANS AND SPECIFICATIONS.
12. ALL COLD WATER LINES SHALL BE TESTED FOR 200 PSI FOR A PERIOD OF TWO (2) HOURS BEFORE COVERING.
13. ALL HOT WATER LINES SHALL BE INSULATED.
14. ALL HOT WATER SHALL BE WATERPROOFED THROUGH ROOF, HANGING, OR APPROVED EQUAL AND SHALL BE TESTED FOR TWO HOURS BEFORE COVERING TO FLOOR TAPPING.
15. ALL WATER LINES SHALL BE HYDRO-STATIC TESTED AT LEAST 200 PSI PRESSURE TO TAPPING.
16. ALL SANITARY LINES, HOT AND COLD WATER LINES SHALL BE PROVIDED WITH SLOPE AS INDICATED AND AS NOTED IN WALL FINISHINGS.
17. NO FIRE SHALL PASS THROUGH EXISTING BEAMS AND COLUMNS.

- MATERIAL SPECIFICATIONS:**
- 1. SOIL AND VENT: POLYETHYLENE CHLORIDE (PVC) PIPES (GRENZ 2000, "MELT-EX", "SMOOTHED EDGES" OR APPROVED EQUAL).
  - 2. DRAIN, WASTE & VENT PIPES: CHLORIDE (PVC) PIPES (GRENZ 2000, "MELT-EX", "SMOOTHED EDGES" OR APPROVED EQUAL).
  - 3. COLD WATER LINE: POLYPROPYLENE (PPR) PIPES IN "MELT-EX" OR APPROVED EQUAL.
  - 4. HOT WATER LINE: POLYPROPYLENE (PPR) PIPES IN "MELT-EX" OR APPROVED EQUAL.
  - 5. VALVES: MANUFACTURED BY "KITE" BRAND OR APPROVED EQUAL.
  - 6. FLOOR DRAIN: MANUFACTURED BY "METHY" BRAND OR APPROVED EQUAL.
  - 7. WALL INSULATION: 25mm POLYURETHANE ISOLATION, WITH FACTORY APPLIED SERVICE WATER BARRIER JACKET.
  - 8. ROOF INSULATION: 25mm THE GLASS WOOL INSULATION.
  - 9. WATER TANK: "MELT-EX" 600 GAL STAINLESS STEEL CULCIB TANK.

**DESIGN LEGENDS:**

- GV  $\Delta$  GATE VALVE
- W WATER METER
- CV  $\nabla$  CHECK VALVE
- WC WATER CLOSET
- WC LAVATORY
- KS KITCHEN SINK
- GT GREASE TRAP
- SHO SHOWER
- HB HOLE BOARD
- CO CLEAN OUT
- POD (OVER CLEAN OUT)
- F FANSET
- WP WATER PUMP
- WT WATER TANK
- 1 TUBILE TUB
- MA MANSHAK
- RP RUSTIC TAP
- FL FLOOR VALVE
- PV FOOT VALVE
- LD LAUNDRY DRAIN
- BS BATH SPRAY
- VTR VENT THRU ROOF
- TD TUB DRAIN
- FD FLOOR DRAIN
- CO GUTTER DRAIN
- CB CATCH BASIN
- DS DOWN SPILT
- SY SEPTIC TANK
- WC WATER CLOSURE
- SS SOIL SPACE
- WT WATER TANK
- IT WITH TUB
- PC FLEX CONNECTOR
- PI INSULATION LAMB
- HT HYDRO-PNEUMATIC
- WP WATER PUMP
- ST STORAGE
- GR GRENZ TANK
- CD CODE DIFFERENTIAL
- COO CODE OF WORK
- WP WATER PUMP
- CP CODE OF WORK
- TRSP 100 LITRE SOLID PPE

**FLOOR DRAIN DETAILS:**

**VENT STACK THRU ROOF:**

**AIR CHAMBER:**

**DETAIL OF FLOOR CLEAN OUT:**

**CATCH BASIN DETAILS:**

**SEPTIC TANK DETAILS:**

**FLOOR DRAIN SCHEDULE:**

NO.	ROOM	TYPE	QTY
1	101	150mm	1
2	102	150mm	1
3	103	150mm	1
4	104	150mm	1
5	105	150mm	1
6	106	150mm	1
7	107	150mm	1
8	108	150mm	1
9	109	150mm	1
10	110	150mm	1



**APPROVED BY:**

*[Signature]*  
**ALAN DE B. PACILLA**  
 REGISTERED PROFESSIONAL ENGINEER

**DESIGNED BY:**

*[Signature]*  
**LUIS E. JARONA, JR.**  
 REGISTERED PROFESSIONAL ENGINEER

**CHECKED BY:**

*[Signature]*  
**JOSE C. WOODEN**  
 REGISTERED PROFESSIONAL ENGINEER

**DATE OF THE SET: 10-10-2024**

**DEPED**

DEPARTMENT OF EDUCATION  
 DIVISION OFFICE - CALABANG  
 DIVISION OFFICE - CALABANG

**PROJECT NO.:** ONE (1) STOREY, TWO (2) CLASSROOMS SCHOOL BUILDING (WITH COMMON TOILET) (ONE BLDG)

**PROJECT SITE:** CALABANG

**DATE:** 10-10-2024

**SCALE:** 1:50

**PROJECT NO.:** P-2

**2**

# ARCHITECTURAL PLAN

(One (1) Storey Three (3) Classrooms School Building with Toilet)



<p>OFFICE OF THE DIRECTOR SCHOOL OF ARCHITECTURE UNIVERSITY OF MICHIGAN ENGINEERING DIVISION</p>	<p><b>TABLE OF CONTENTS</b></p> <p><b>ARCHITECTURAL</b></p> <ul style="list-style-type: none"> <li>A-1 - SHEET COVER</li> <li>A-2 - SITE PLAN</li> <li>A-3 - FLOOR PLAN</li> <li>A-4 - SECTION</li> <li>A-5 - ELEVATION</li> <li>A-6 - EXTERIOR FINISH</li> <li>A-7 - INTERIOR FINISH</li> <li>A-8 - MECHANICAL</li> <li>A-9 - ELECTRICAL</li> <li>A-10 - SANITARY</li> <li>A-11 - STRUCTURAL</li> <li>A-12 - LAND USE &amp; ZONING</li> </ul>	 <p style="text-align: center;"><b>PERSPECTIVE</b></p>	<p><b>ARCHITECTURAL</b></p> <ul style="list-style-type: none"> <li>A-1 - SHEET COVER</li> <li>A-2 - SITE PLAN</li> <li>A-3 - FLOOR PLAN</li> <li>A-4 - SECTION</li> <li>A-5 - ELEVATION</li> <li>A-6 - EXTERIOR FINISH</li> <li>A-7 - INTERIOR FINISH</li> <li>A-8 - MECHANICAL</li> <li>A-9 - ELECTRICAL</li> <li>A-10 - SANITARY</li> <li>A-11 - STRUCTURAL</li> <li>A-12 - LAND USE &amp; ZONING</li> </ul>
<p>OFFICE OF THE DIRECTOR SCHOOL OF ARCHITECTURE UNIVERSITY OF MICHIGAN ENGINEERING DIVISION</p>	<p><b>TABLE OF CONTENTS</b></p> <p><b>ARCHITECTURAL</b></p> <ul style="list-style-type: none"> <li>A-1 - SHEET COVER</li> <li>A-2 - SITE PLAN</li> <li>A-3 - FLOOR PLAN</li> <li>A-4 - SECTION</li> <li>A-5 - ELEVATION</li> <li>A-6 - EXTERIOR FINISH</li> <li>A-7 - INTERIOR FINISH</li> <li>A-8 - MECHANICAL</li> <li>A-9 - ELECTRICAL</li> <li>A-10 - SANITARY</li> <li>A-11 - STRUCTURAL</li> <li>A-12 - LAND USE &amp; ZONING</li> </ul>	<p><b>ARCHITECTURAL</b></p> <ul style="list-style-type: none"> <li>A-1 - SHEET COVER</li> <li>A-2 - SITE PLAN</li> <li>A-3 - FLOOR PLAN</li> <li>A-4 - SECTION</li> <li>A-5 - ELEVATION</li> <li>A-6 - EXTERIOR FINISH</li> <li>A-7 - INTERIOR FINISH</li> <li>A-8 - MECHANICAL</li> <li>A-9 - ELECTRICAL</li> <li>A-10 - SANITARY</li> <li>A-11 - STRUCTURAL</li> <li>A-12 - LAND USE &amp; ZONING</li> </ul>	<p><b>ARCHITECTURAL</b></p> <ul style="list-style-type: none"> <li>A-1 - SHEET COVER</li> <li>A-2 - SITE PLAN</li> <li>A-3 - FLOOR PLAN</li> <li>A-4 - SECTION</li> <li>A-5 - ELEVATION</li> <li>A-6 - EXTERIOR FINISH</li> <li>A-7 - INTERIOR FINISH</li> <li>A-8 - MECHANICAL</li> <li>A-9 - ELECTRICAL</li> <li>A-10 - SANITARY</li> <li>A-11 - STRUCTURAL</li> <li>A-12 - LAND USE &amp; ZONING</li> </ul>





NOTE:  
 PROVIDE THE SUBSTITUTED  
 FIBERGLASS INSULATION IN  
 THE SCHOOL BUILDING SITE LOCATED  
 NEAR BAYANDEG (DAGUATA) AREA  
 PRIOR TO CONSTRUCTION OF THE ROOFING.  
 THE ROOFING SHALL BE INSTALLED  
 IMMEDIATELY AFTER THE ROOFING  
 CONTRACTORS SHALL BE USED AS  
 ALTERNATE MATERIALS.

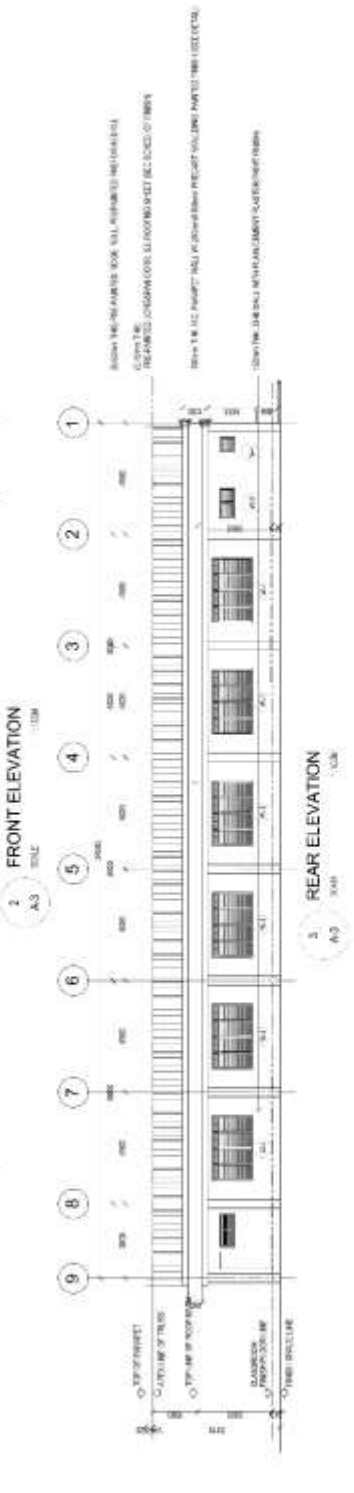
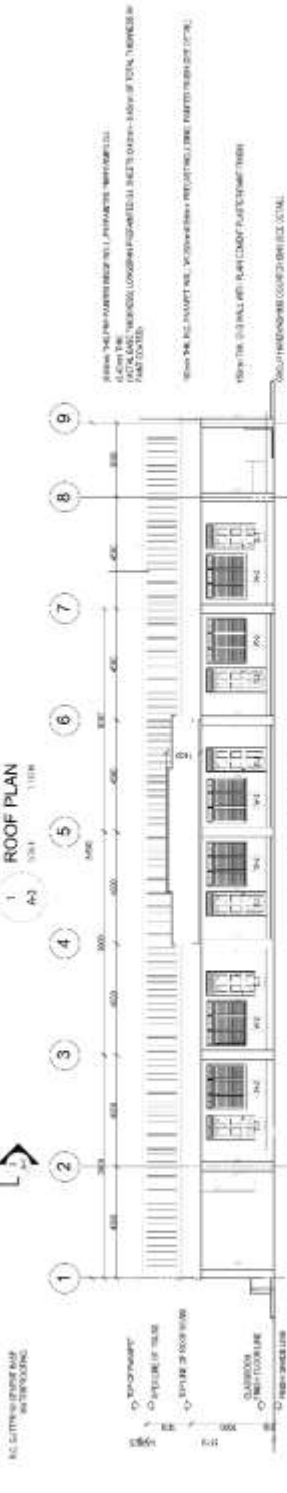
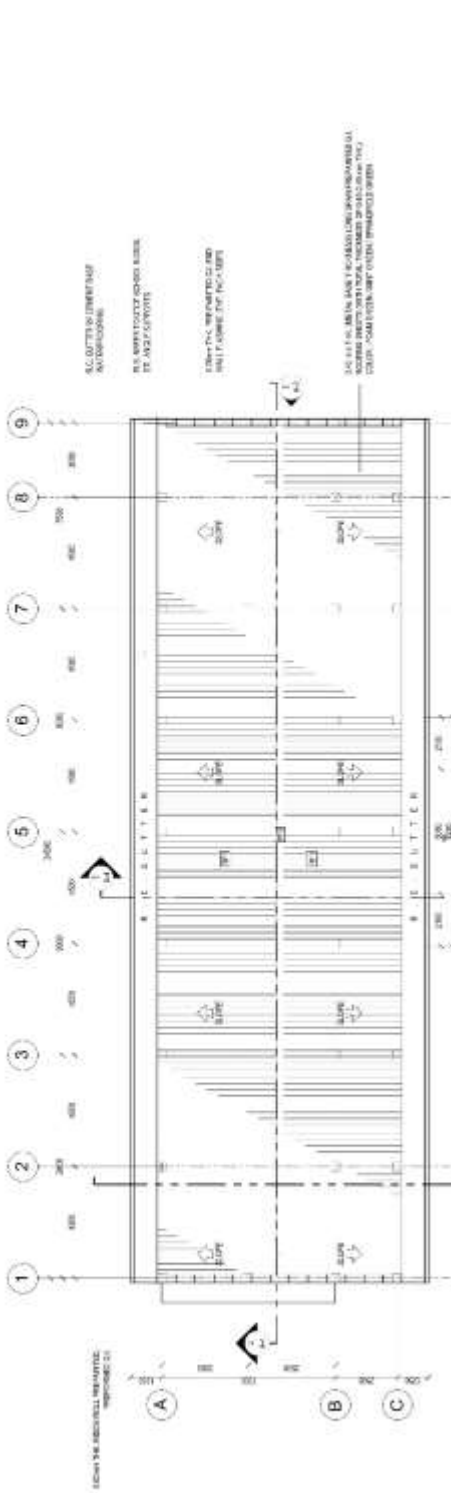

 REPUBLIC OF THE PHILIPPINES <b>DepEd</b> DEPARTMENT OF EDUCATION DIVISION OFFICE - BAYANDEG BAYANDEG, DAVAO DEL SUR	PROJECT NO. 1 PROJECT TITLE <b>ONE (1) STOREY THREE (3) CLASSROOM</b> <b>SCHOOL BUILDING</b> (PER COMMON TOILETS (ONE SET))	PROJECT NO. 1 PROJECT TITLE <b>DEPARTMENT OF EDUCATION</b> <b>DepEd</b> BAYANDEG	SHEET NO. 7 TOTAL SHEETS 7 <b>A-3</b>
	DESIGNER JUAN DELA ROSA ARCHITECTURE & CONSULTING	ARCHITECT ANABELLE B. ALPHEAN ARCHITECTURE & CONSULTING	CHECKER LUIS P. FORTALES, JR. ARCHITECT

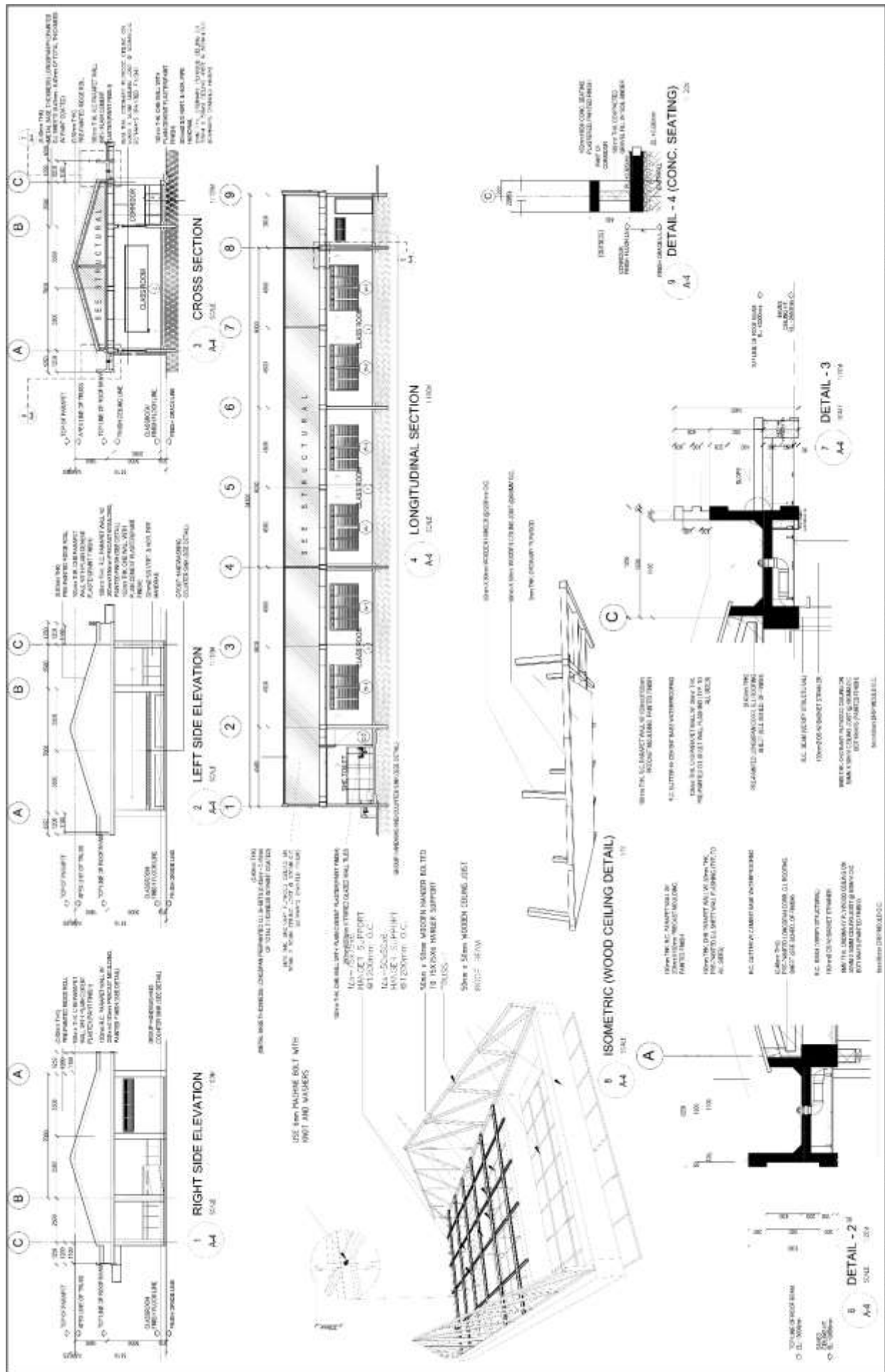

	DEPARTMENT OF EDUCATION DeptED	PROJECT CODE:	SHEET NO:	SHEET NO:
PROJECT TITLE:	PROJECT CODE:	SHEET NO:	SHEET NO:	SHEET NO:
PROJECT TITLE:	PROJECT CODE:	SHEET NO:	SHEET NO:	SHEET NO:
PROJECT TITLE:	PROJECT CODE:	SHEET NO:	SHEET NO:	SHEET NO:

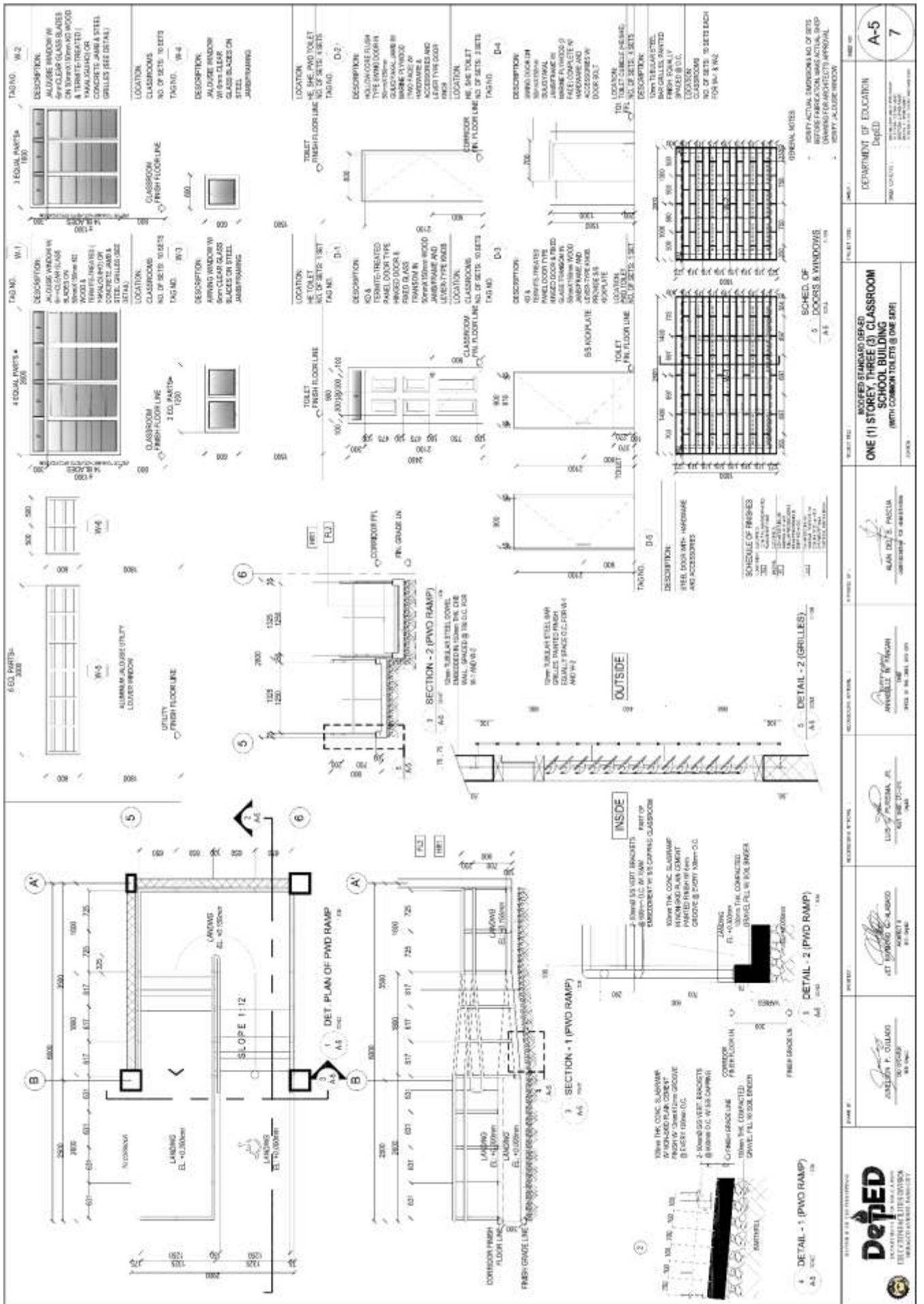



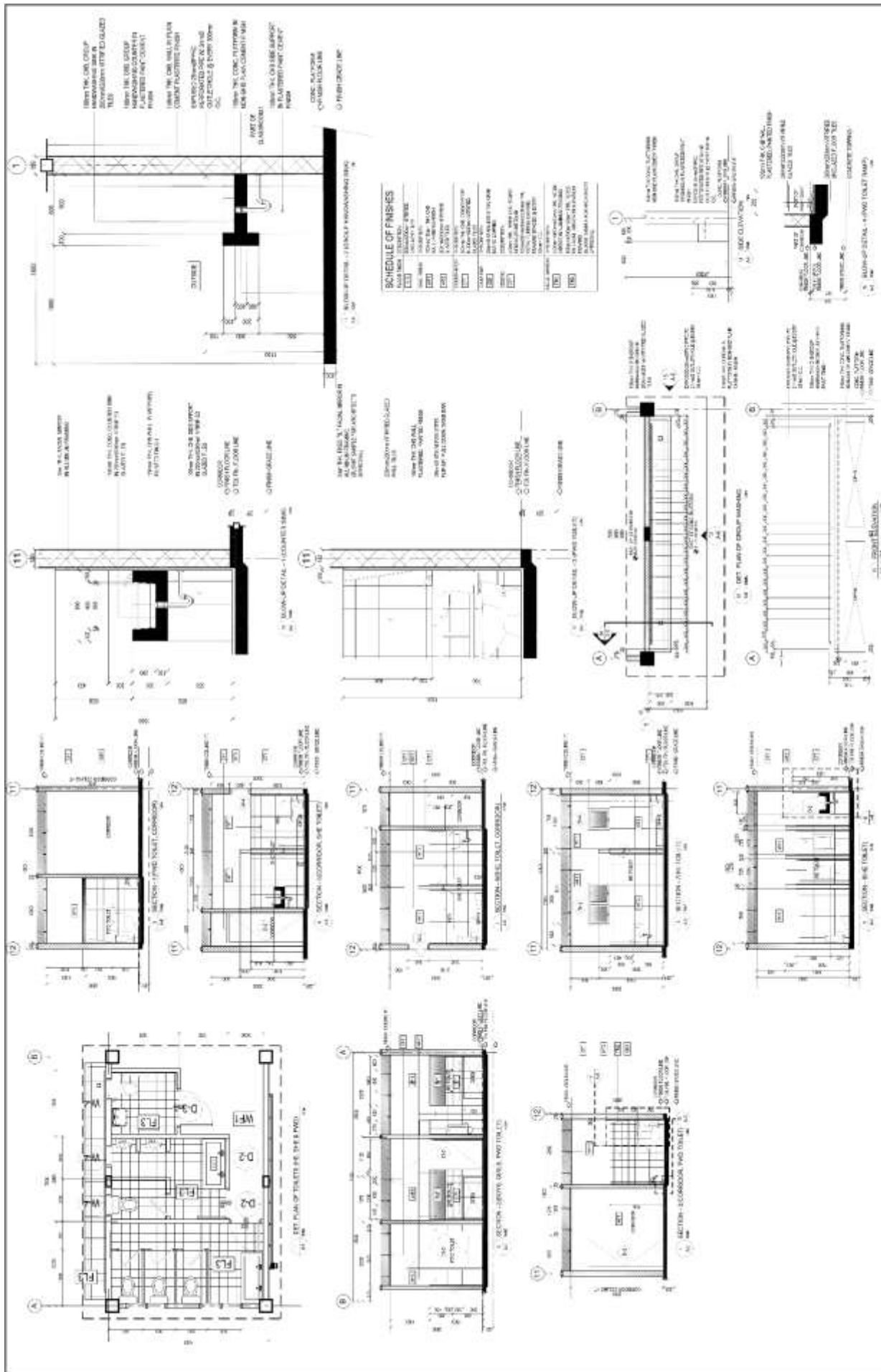

SHEET NO. **A-6**  
 PROJECT NO. **7**  
 DEPARTMENT OF EDUCATION  
 (bepd)  
 1000 N. GARDNER ST., SUITE 100  
 DENVER, CO 80202  
 PHONE: (303) 733-7000  
 FAX: (303) 733-7001  
 WWW: www.doe.state.co.us

WORKS SHOWN ON THIS SHEET:  
**ONE (1) STOREY THREE (3) CLASSROOM**  
**SCHOOL BUILDING**  
**(WITH COMMON TOILETS & ONE BEE)**

DRAWN BY: *[Signature]*  
 CHECKED BY: *[Signature]*  
 APPROVED BY: *[Signature]*  
 DATE: 10/15/03

SCALE: AS SHOWN  
 DATE: 10/15/03

SHEET NO. **A-6**  
 PROJECT NO. **7**

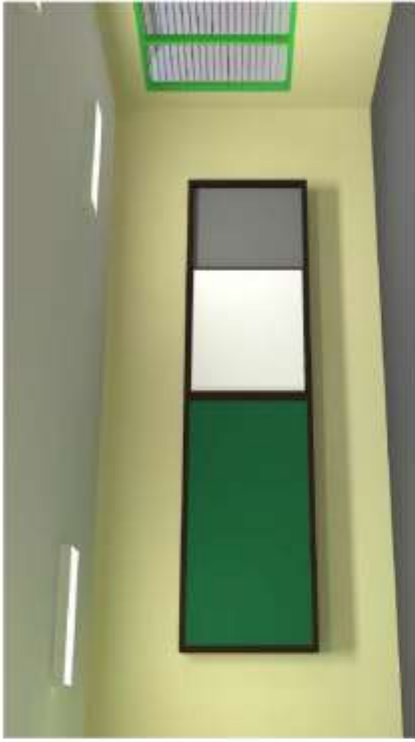

ITEM	DESCRIPTION	REMARKS	TECHNICAL SPECIFICATION
A	CHALKBOARD	36" x 72" x 1/2" thick	WOOD-panels, 3/4" thick, w/ at least 2 coats of 100 mil wet applied epoxy
B	WALL MOUNTED CHALKBOARD	36" x 72" x 1/2" thick	ALL FINISHES—provided w/ 50% UP
C	WALL MOUNTED WHITEBOARD	36" x 72" x 1/2" thick	ALL FINISHES—provided w/ 50% UP
D	WALL MOUNTED CHALKBOARD	36" x 72" x 1/2" thick	ALL FINISHES—provided w/ 50% UP
E	WOOD CABINET	36" x 72" x 1/2"	

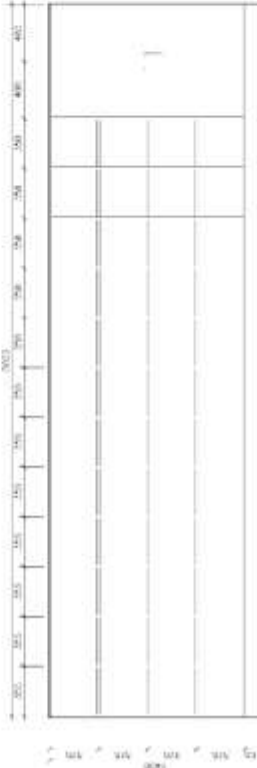
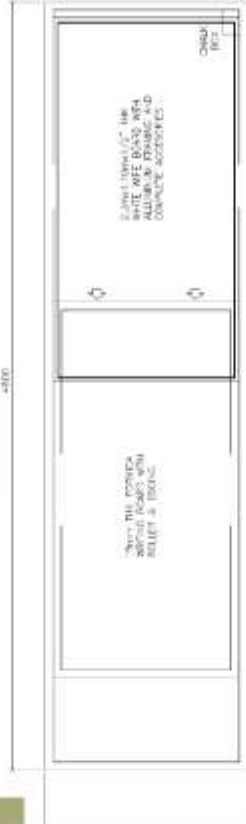

# FILING CABINET

# BLACKBOARD

	<b>DEPED</b> DEPARTMENT OF EDUCATION STATE OF FLORIDA DIVISION OF FACILITIES MANAGEMENT	SHEET NO. <b>A-1</b>	PROJECT NO. <b>OTHER FACILITIES FOR LAST MILE SCHOOLS</b>	SHEET TITLE <b>BLACKBOARD</b>	DRAWN BY <b>ALAN DEL P. PANGILA</b> ARCHITECT FOR ARCHITECTURE	CHECKED BY <b>ALAN DEL P. PANGILA</b> ARCHITECT FOR ARCHITECTURE	DATE <b>DEPARTMENT OF EDUCATION</b> <b>STATE OF FLORIDA</b>
--	--	-------------------------	--	----------------------------------	--	--	---

# STRUCTURAL PLAN

(One (1) Storey Three (3) Classrooms School Building with Toilet)









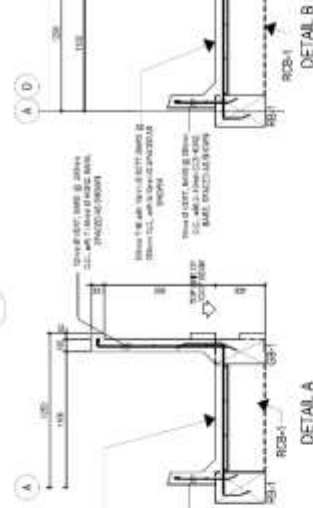
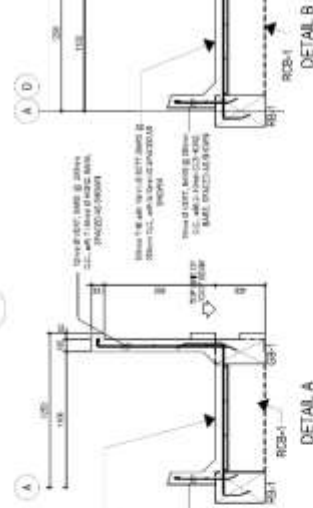
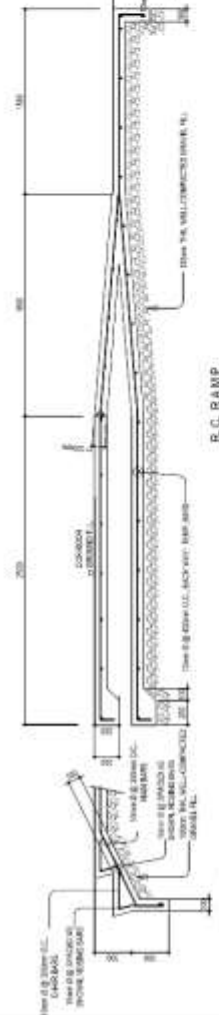
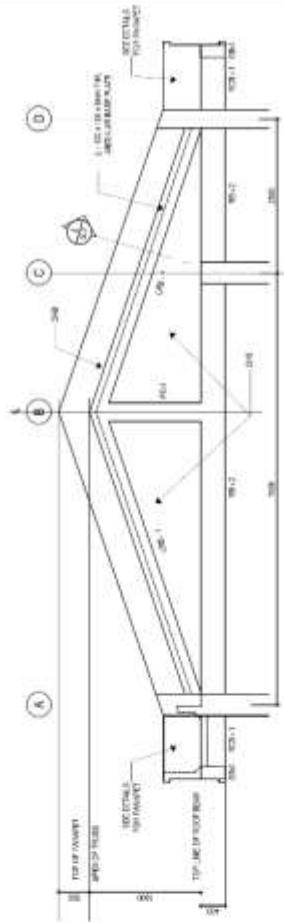
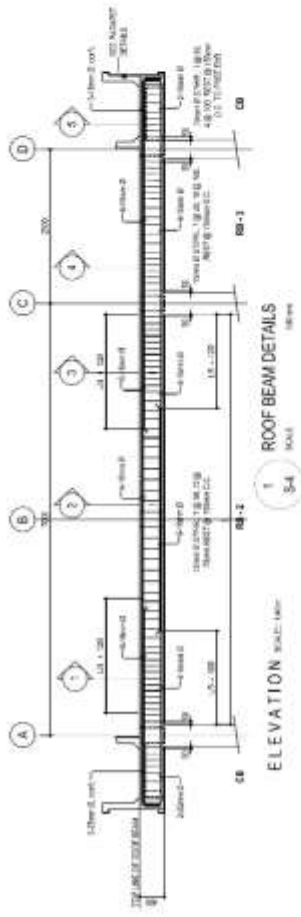
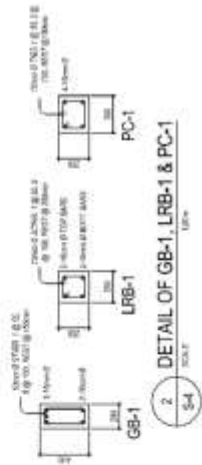
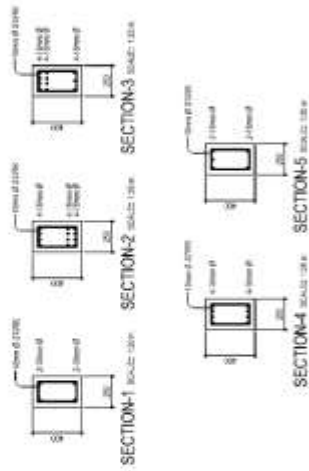

	PROJECT NO.: ONE (1) STORY, THREE (3) CLASSROOM WITH COMMON BATHS (SEE 050)	PROJECT DATE: 05/2014	ARCHITECT: ALAN SELB, ARCHITECT ARCHITECTS FOR EDUCATION	CONTRACTOR: LUIS A. ARRIAGA, JR. LUIS A. ARRIAGA, JR. 1001 W. 101ST ST. CHICAGO, IL 60643	ENGINEER: JACQUES T. CHICAGO JACQUES T. CHICAGO 1001 W. 101ST ST. CHICAGO, IL 60643	DRAWING NO.: S-4 8
	DEPARTMENT OF EDUCATION DeptEd 1001 W. 101ST ST. CHICAGO, IL 60643	ARCHITECT: ALAN SELB, ARCHITECT ARCHITECTS FOR EDUCATION	CONTRACTOR: LUIS A. ARRIAGA, JR. LUIS A. ARRIAGA, JR. 1001 W. 101ST ST. CHICAGO, IL 60643	ENGINEER: JACQUES T. CHICAGO JACQUES T. CHICAGO 1001 W. 101ST ST. CHICAGO, IL 60643	DRAWING NO.: S-4 8	

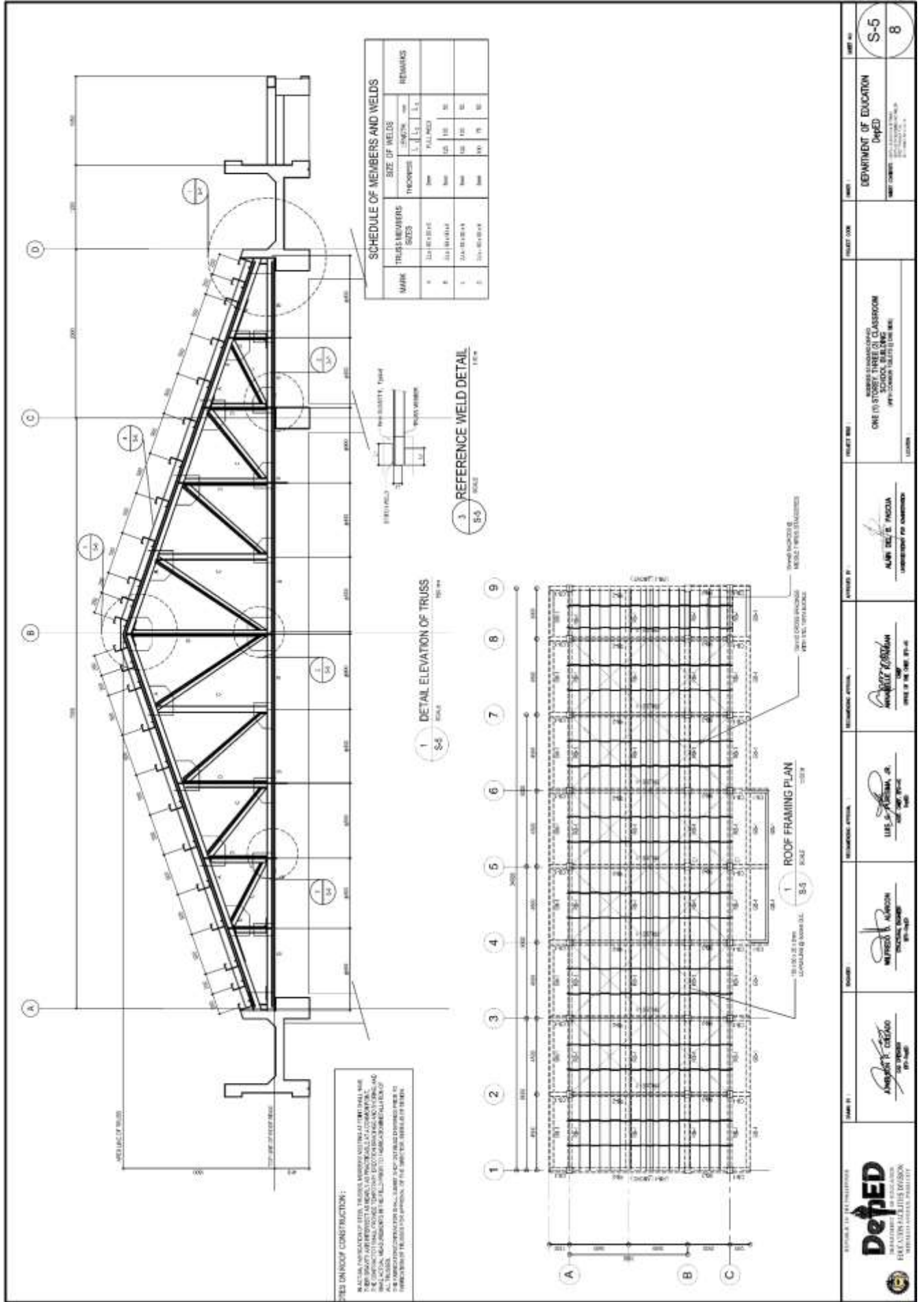

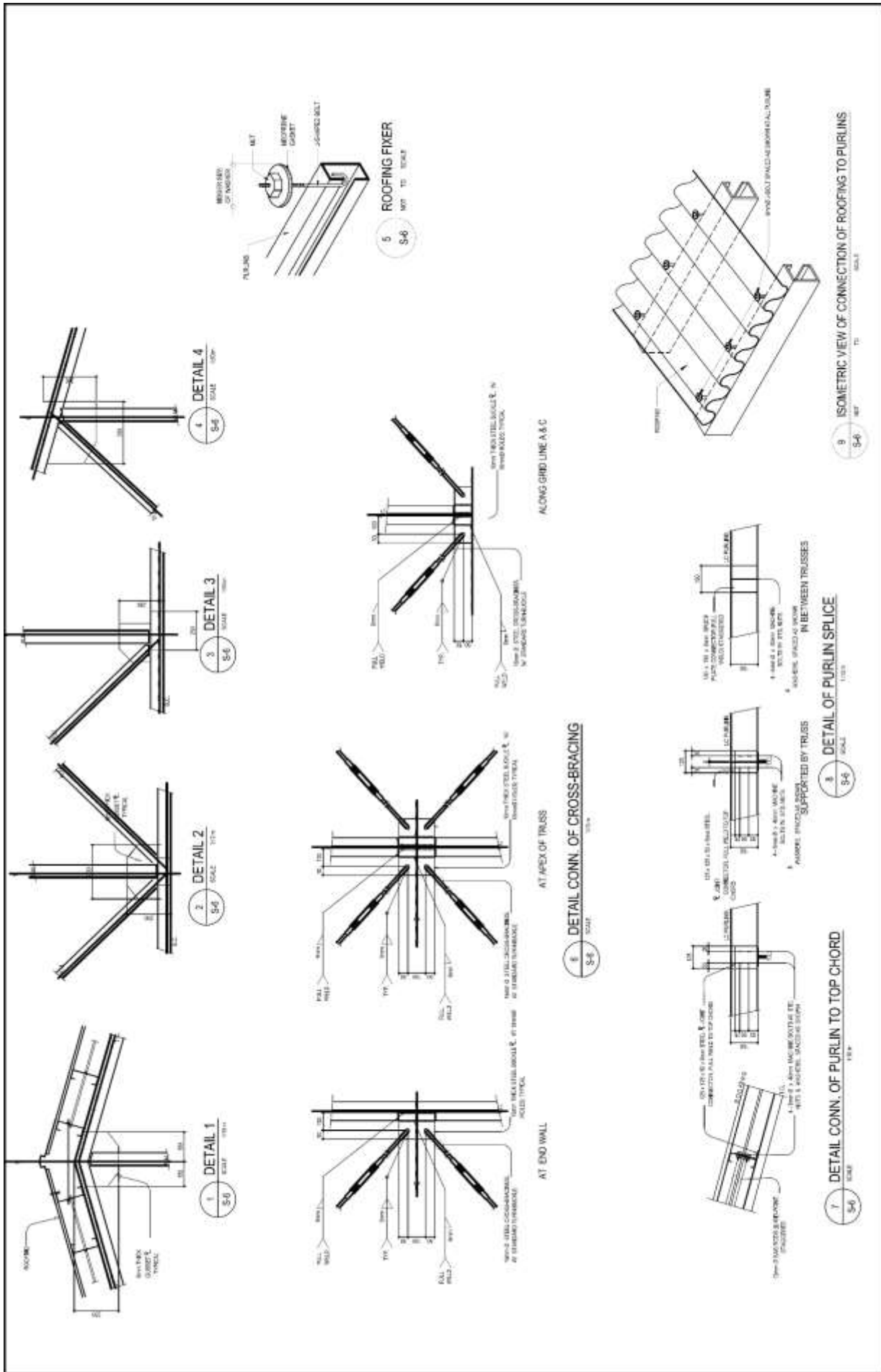

 <b>DepEd</b> DIVISION OFFICE - CAGAYAN DE ORO DEPARTMENT OF EDUCATION OFFICE OF THE DIVISION SUPERVISOR	PROJECT NO. <b>S-6</b>	SHEET NO. <b>8</b>
	PROJECT NAME <b>ROOFING AND BRACING OF CLASSROOM</b> (ONE (1) STOREY TYPE)	ARCHITECT <b>ALAN DELA ROSA</b> ARCHITECTURE FOR AMBASSADORS
DRAWN BY <b>ALAN DELA ROSA</b> ARCHITECTURE FOR AMBASSADORS	CHECKED BY <b>ALAN DELA ROSA</b> ARCHITECTURE FOR AMBASSADORS	PROJECT DATE <b>2023</b>
DESIGNED BY <b>ALAN DELA ROSA</b> ARCHITECTURE FOR AMBASSADORS	APPROVED BY <b>ALAN DELA ROSA</b> ARCHITECTURE FOR AMBASSADORS	DATE <b>2023</b>

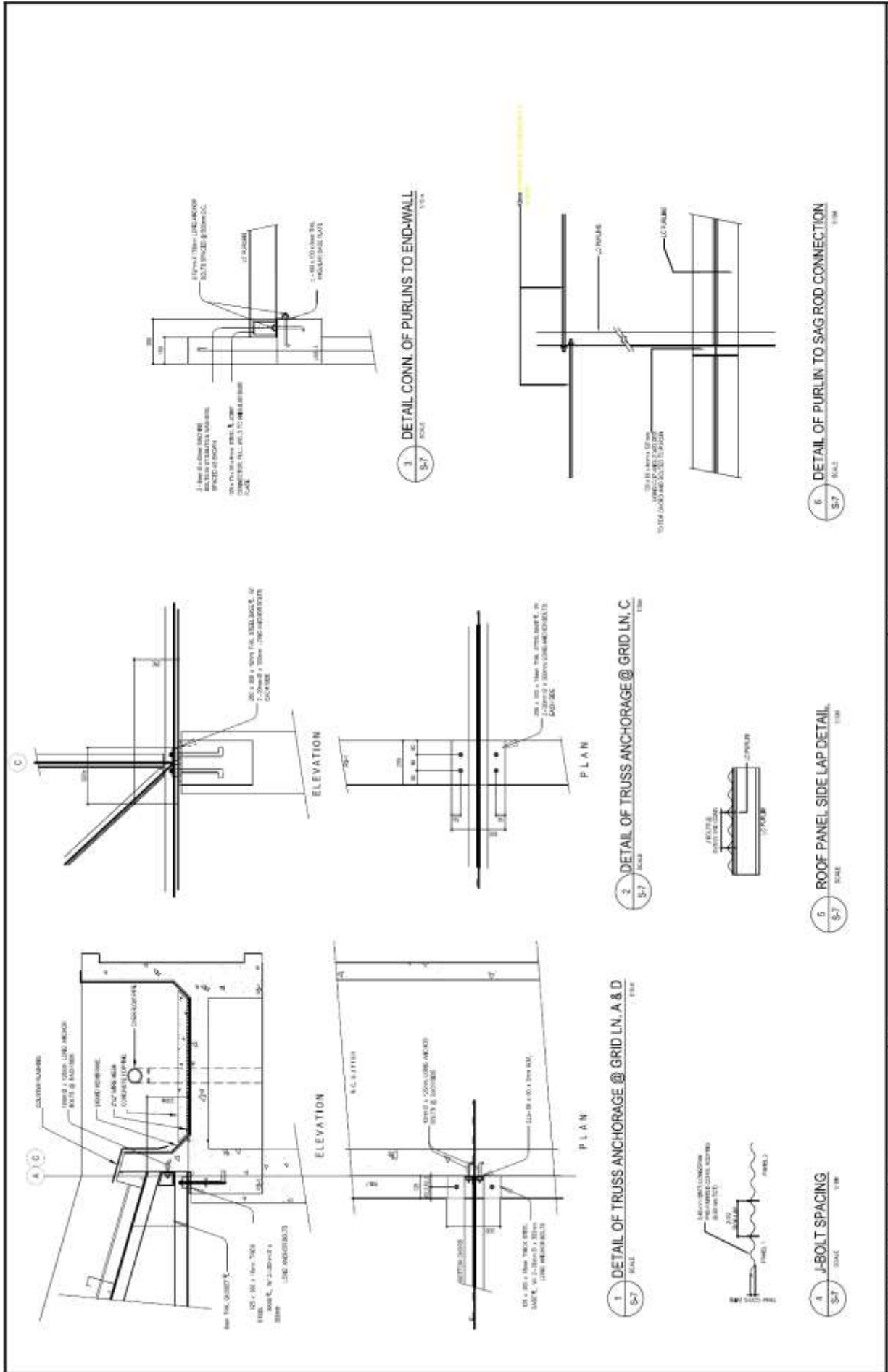

<p><b>DepEd</b> DIVISION OFFICE - MARIKINA CITY SCHOOL DIVISION OFFICE</p>	<p>DESIGNED BY: <i>[Signature]</i> ENGR. RICHARD T. LARSON REGISTERED PROFESSIONAL ENGINEER</p>	<p>DESIGNED BY: <i>[Signature]</i> ENGR. RICHARD T. LARSON REGISTERED PROFESSIONAL ENGINEER</p>	<p>DESIGNED BY: <i>[Signature]</i> ENGR. RICHARD T. LARSON REGISTERED PROFESSIONAL ENGINEER</p>	<p>DESIGNED BY: <i>[Signature]</i> ENGR. RICHARD T. LARSON REGISTERED PROFESSIONAL ENGINEER</p>	<p>PROJECT TITLE: <b>ONE (1) STUDENT LEARNING CLASSROOM</b> MARIKINA CITY, MARIKINA CITY, MARIKINA CITY</p>	<p>PROJECT CODE: <b>DEPED - MARIKINA CITY</b></p>	<p>DATE: <b>2024-08-08</b></p>
	<p>DATE: <b>2024-08-08</b></p>	<p>DATE: <b>2024-08-08</b></p>	<p>DATE: <b>2024-08-08</b></p>	<p>DATE: <b>2024-08-08</b></p>	<p>DATE: <b>2024-08-08</b></p>	<p>DATE: <b>2024-08-08</b></p>	<p>DATE: <b>2024-08-08</b></p>



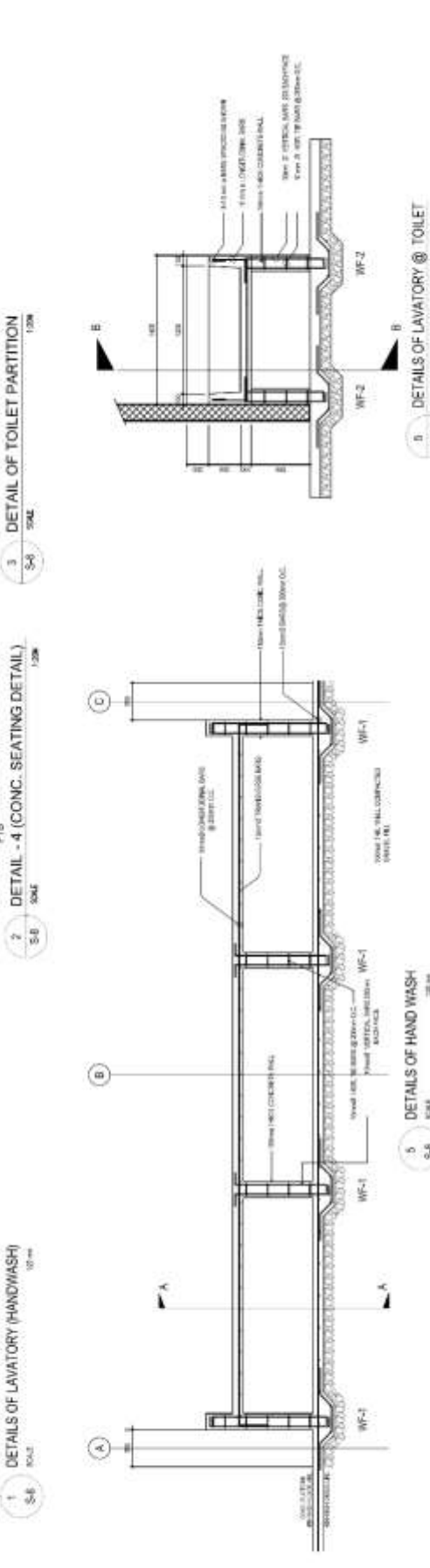
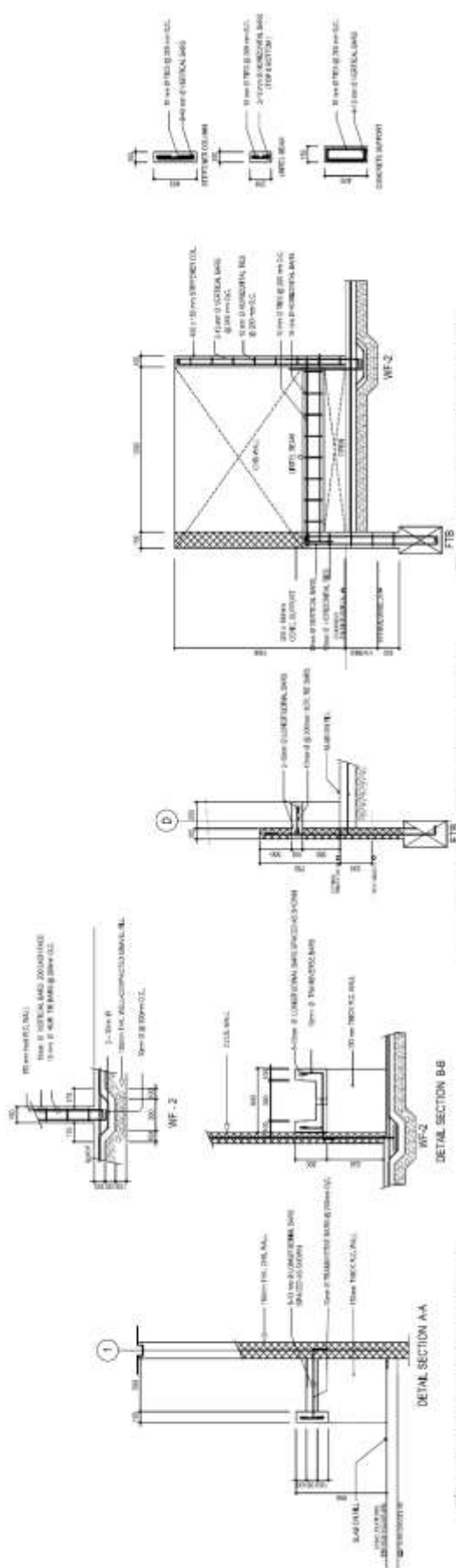

 <b>DepED</b> DEPARTMENT OF EDUCATION REGIONAL OFFICE - CAGAYAN DIVISION OFFICE - CAGAYAN CITY	DRAWN BY: JOSEPH F. ORDOÑEZ ARCHITECT	CHECKED BY: ALFREDO ALARCON SENIOR ARCHITECT	REVIEWED BY: LUIS J. ROSALES, JR. SENIOR ARCHITECT	REVISIONS: ANABELLE TORONDO ARCHITECT	APPROVED BY: ALAN DELA ROSA SUPERVISOR OF CONSTRUCTION	PROJECT TITLE: ONE (1) STOREY INTEGRATED CLASSROOM (RE-CONSTRUCTION OF ONE UNIT)	PROJECT CODE: DEPARTMENT OF EDUCATION DepEd	SHEET NO: S-8 8
	SHEET TITLE: DETAILS OF LAVATORY @ TOILET							

# ELECTRICAL PLAN

(One (1) Storey Three (3) Classrooms School Building with Toilet)

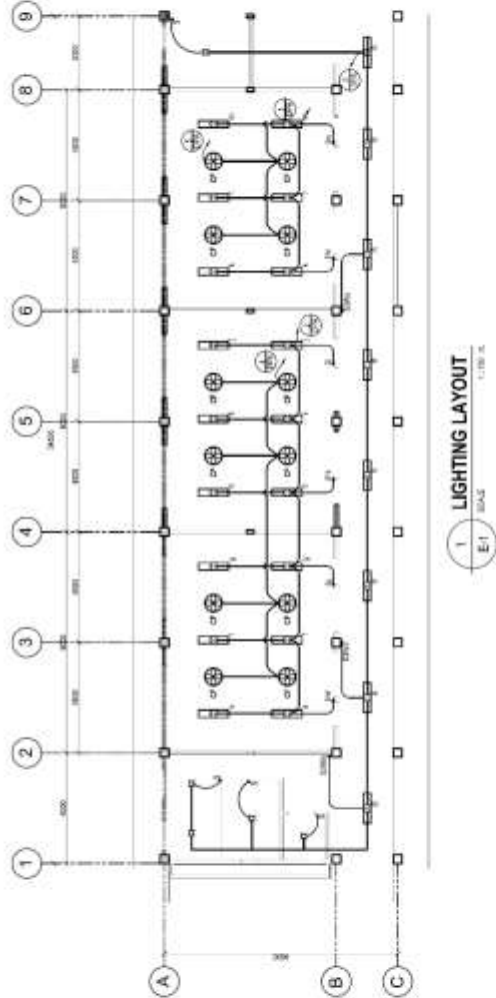
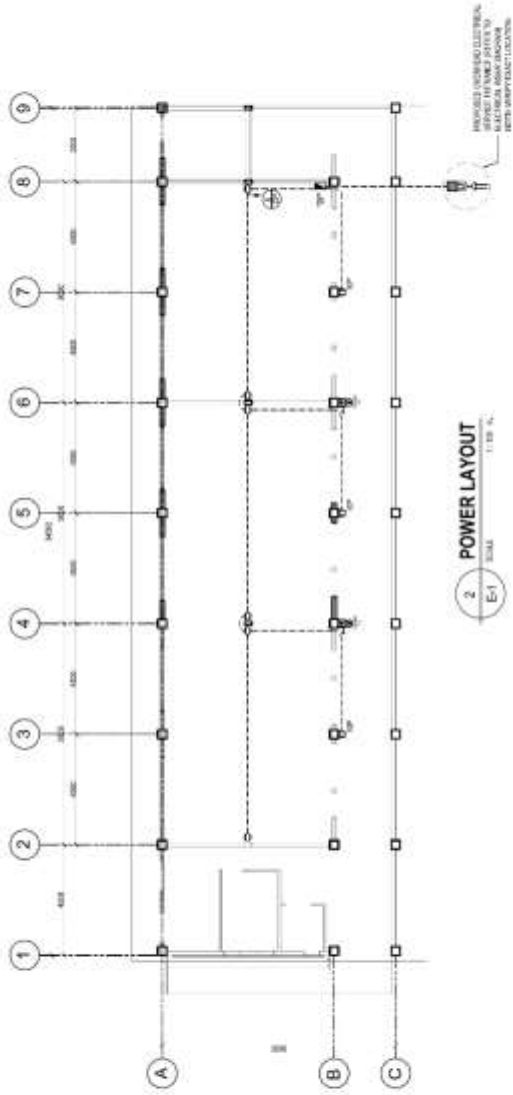

	 JOHN P. LORIDO DIRECTOR	 FELIX S. MACANONG DIVISION OFFICE DIRECTOR	 LIZA S. ARMAS, JR. DIVISION OFFICE DIRECTOR	 ARROYO DIVISION OFFICE DIRECTOR	 ALAN DEL B. PINEDA DEPARTMENT OF MANAGEMENT	PROJECT TITLE: <b>RENOVATION OF CLASSROOMS          ONE (1) STATE SCHOOL BUILDING          WITH TRAILER (ONE SET)</b> <small>LOCUS: TAMBULOGAN SCHOOL</small>	PROJECT CODE: DEPARTMENT OF EDUCATION DivEd	SHEET NO. <b>E-1</b> 2
	DEPARTMENT OF EDUCATION DIVISION OFFICE TAMBULOGAN SCHOOL							

### 1 SINGLE LINE DIAGRAM

E-2 30x41

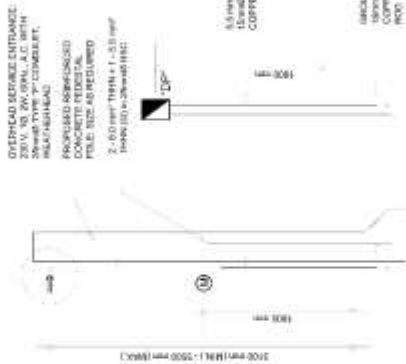

OVERHEAD SERVICE ENTRANCE  
200V/100V TRANSFORMER WITH  
200V/100V METER  
PROCESSED REINFORCED  
CONCRETE FOOTING  
FOOTING SIZE AS REQUIRED  
200V/100V BREAKER  
200V/100V FEEDER

200V/100V FEEDER  
200V/100V BUS  
200V/100V BREAKER  
200V/100V METER  
200V/100V TRANSFORMER  
200V/100V SERVICE ENTRANCE

### GENERAL NOTES:

- ALL ELECTRICAL WORK SHALL BE DONE IN ACCORDANCE WITH THE PROVISIONS OF THE RULES, REGULATIONS AND ORDINANCES OF THE ELECTRICAL BOARD AND THE ELECTRICAL CODES OF THE ELECTRICAL BOARD AND THE ELECTRICAL CODES OF THE ELECTRICAL BOARD AND THE ELECTRICAL CODES OF THE ELECTRICAL BOARD.
- THE TYPE OF SERVICE ENTRANCE SHALL BE AS SHOWN ON THE DRAWING UNLESS OTHERWISE SPECIFIED.
- THE SERVICE ENTRANCE SHALL BE INSTALLED IN ACCORDANCE WITH THE ELECTRICAL CODES OF THE ELECTRICAL BOARD AND THE ELECTRICAL CODES OF THE ELECTRICAL BOARD AND THE ELECTRICAL CODES OF THE ELECTRICAL BOARD.
- ALL ELECTRICAL WORK SHALL BE DONE IN ACCORDANCE WITH THE PROVISIONS OF THE RULES, REGULATIONS AND ORDINANCES OF THE ELECTRICAL BOARD AND THE ELECTRICAL CODES OF THE ELECTRICAL BOARD AND THE ELECTRICAL CODES OF THE ELECTRICAL BOARD.
- ALL ELECTRICAL WORK SHALL BE DONE IN ACCORDANCE WITH THE PROVISIONS OF THE RULES, REGULATIONS AND ORDINANCES OF THE ELECTRICAL BOARD AND THE ELECTRICAL CODES OF THE ELECTRICAL BOARD AND THE ELECTRICAL CODES OF THE ELECTRICAL BOARD.
- ALL ELECTRICAL WORK SHALL BE DONE IN ACCORDANCE WITH THE PROVISIONS OF THE RULES, REGULATIONS AND ORDINANCES OF THE ELECTRICAL BOARD AND THE ELECTRICAL CODES OF THE ELECTRICAL BOARD AND THE ELECTRICAL CODES OF THE ELECTRICAL BOARD.
- ALL ELECTRICAL WORK SHALL BE DONE IN ACCORDANCE WITH THE PROVISIONS OF THE RULES, REGULATIONS AND ORDINANCES OF THE ELECTRICAL BOARD AND THE ELECTRICAL CODES OF THE ELECTRICAL BOARD AND THE ELECTRICAL CODES OF THE ELECTRICAL BOARD.
- ALL ELECTRICAL WORK SHALL BE DONE IN ACCORDANCE WITH THE PROVISIONS OF THE RULES, REGULATIONS AND ORDINANCES OF THE ELECTRICAL BOARD AND THE ELECTRICAL CODES OF THE ELECTRICAL BOARD AND THE ELECTRICAL CODES OF THE ELECTRICAL BOARD.
- ALL ELECTRICAL WORK SHALL BE DONE IN ACCORDANCE WITH THE PROVISIONS OF THE RULES, REGULATIONS AND ORDINANCES OF THE ELECTRICAL BOARD AND THE ELECTRICAL CODES OF THE ELECTRICAL BOARD AND THE ELECTRICAL CODES OF THE ELECTRICAL BOARD.
- ALL ELECTRICAL WORK SHALL BE DONE IN ACCORDANCE WITH THE PROVISIONS OF THE RULES, REGULATIONS AND ORDINANCES OF THE ELECTRICAL BOARD AND THE ELECTRICAL CODES OF THE ELECTRICAL BOARD AND THE ELECTRICAL CODES OF THE ELECTRICAL BOARD.

### ELECTRICAL SYMBOLS:



### SCHEDULE OF LIGHTING FIXTURES AND LAMPS:

SYMBOL	DESCRIPTION	REMARKS
□	200V/100V FEEDER WITH OVERCURRENT PROTECTION	200V/100V FEEDER WITH OVERCURRENT PROTECTION
□	200V/100V BUS	200V/100V BUS
□	200V/100V BREAKER	200V/100V BREAKER
□	200V/100V METER	200V/100V METER
□	200V/100V TRANSFORMER	200V/100V TRANSFORMER
□	200V/100V SERVICE ENTRANCE	200V/100V SERVICE ENTRANCE

200V/100V FEEDER  
200V/100V BUS  
200V/100V BREAKER  
200V/100V METER  
200V/100V TRANSFORMER  
200V/100V SERVICE ENTRANCE

### 2 SCHEDULE OF LOADS

E-2 30x41

NO.	DESCRIPTION	VOLT	AMPERE	WATT	VA	SERIES OF LOADS		MAIN FEEDER USE		MAIN FEEDER USE	
						NO.	VA	NO.	VA	NO.	VA
1	LIGHTING	200	100	20000	20000	1	20000	1	20000	1	20000
2	POWER	200	100	20000	20000	1	20000	1	20000	1	20000
3	HEATING	200	100	20000	20000	1	20000	1	20000	1	20000
4	CHEMICAL	200	100	20000	20000	1	20000	1	20000	1	20000
5	RESEARCH	200	100	20000	20000	1	20000	1	20000	1	20000
6	LABORATORY	200	100	20000	20000	1	20000	1	20000	1	20000
7	OFFICE	200	100	20000	20000	1	20000	1	20000	1	20000
8	STORAGE	200	100	20000	20000	1	20000	1	20000	1	20000
9	OTHER	200	100	20000	20000	1	20000	1	20000	1	20000
<b>TOTAL</b>		200	100	20000	20000	1	20000	1	20000	1	20000

### 3 ELECTRICAL RISER DIAGRAM

E-2 30x41

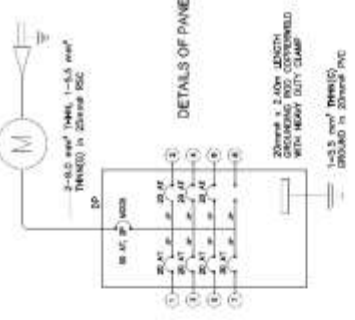

200V/100V FEEDER  
200V/100V BUS  
200V/100V BREAKER  
200V/100V METER  
200V/100V TRANSFORMER  
200V/100V SERVICE ENTRANCE

### DETAILS OF PANEL BOARDS

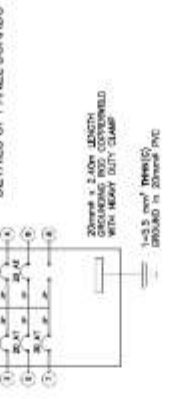

200V/100V FEEDER  
200V/100V BUS  
200V/100V BREAKER  
200V/100V METER  
200V/100V TRANSFORMER  
200V/100V SERVICE ENTRANCE

DEPED  
DIVISION OF EDUCATION  
OFFICE OF THE SUPERINTENDING EDUCATION OFFICER  
EDUCATION HALL, DIVISION OFFICE  
EDUCATION HALL, DIVISION OFFICE

DATE: 10/10/2023  
DRAWN BY: [Signature]  
CHECKED BY: [Signature]  
APPROVED BY: [Signature]

PROJECT NO: [Blank]  
PROJECT NAME: [Blank]

NO. OF SHEETS: 2  
SHEET NO: 2



# PLUMBING PLAN

(One (1) Storey Three (3) Classrooms School Building with Toilet)

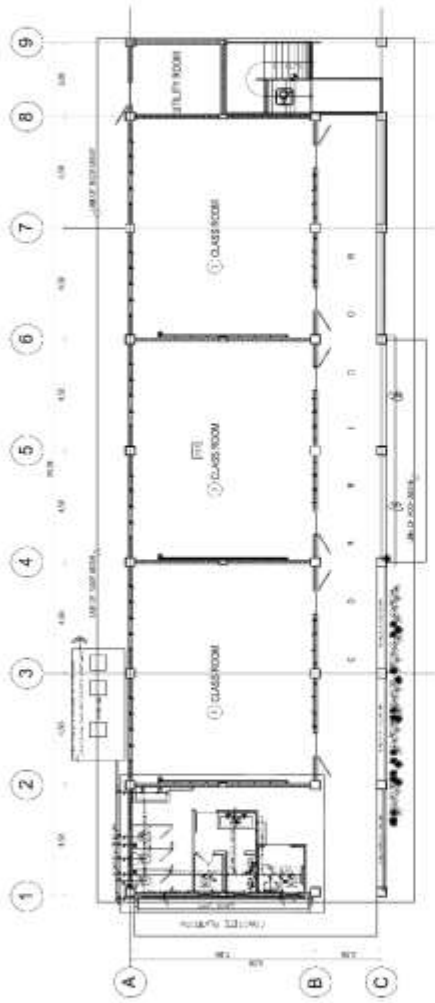

2 FLOOR PLAN SEWER LINE LAYOUT  
SCALE: 1/8"=1'-0"

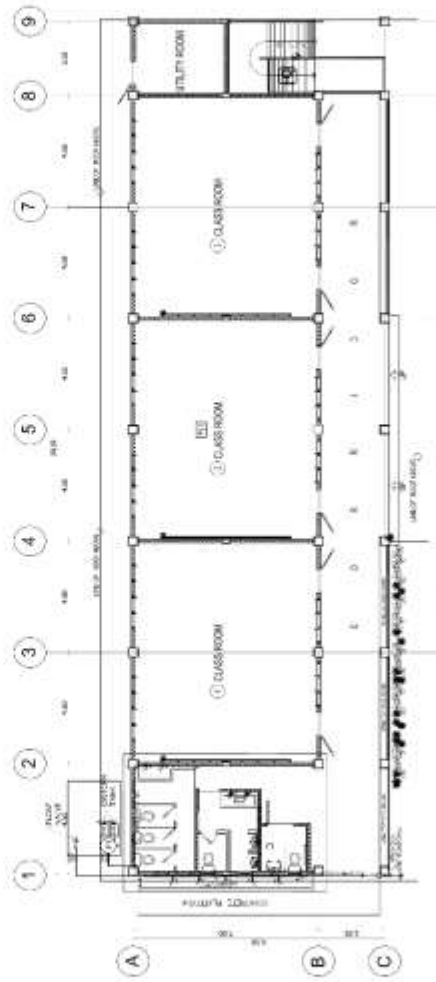

1 FLOOR PLAN WATER LINE LAYOUT  
SCALE: 1/8"=1'-0"

	 ALEXANDER F. GALLARDO DIRECTOR OF CONSTRUCTION SERVICES	 LISA C. FERRARA, JR. DIRECTOR OF PLANNING	 ROBERT E. PINCELLA DIRECTOR OF OPERATIONS	PROJECT NAME: <b>MOHAWK STATE UNIVERSITY SCHOOL BUILDING (ONE (1) STOREY, THREE (3) CLASSROOM (PREF-COMM) BUILDING (ONE AND ONE))</b>	SHEET NO.: <b>P-1</b> OF 3
	DATE:	DRAWN BY:	CHECKED BY:	DEPARTMENT OF EDUCATION DESIGNED BY:	SHEET NO.: <b>3</b>

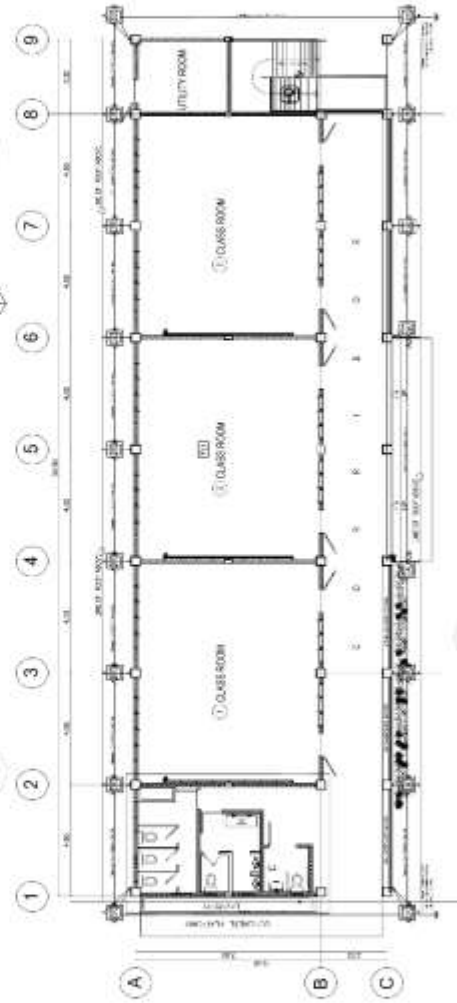
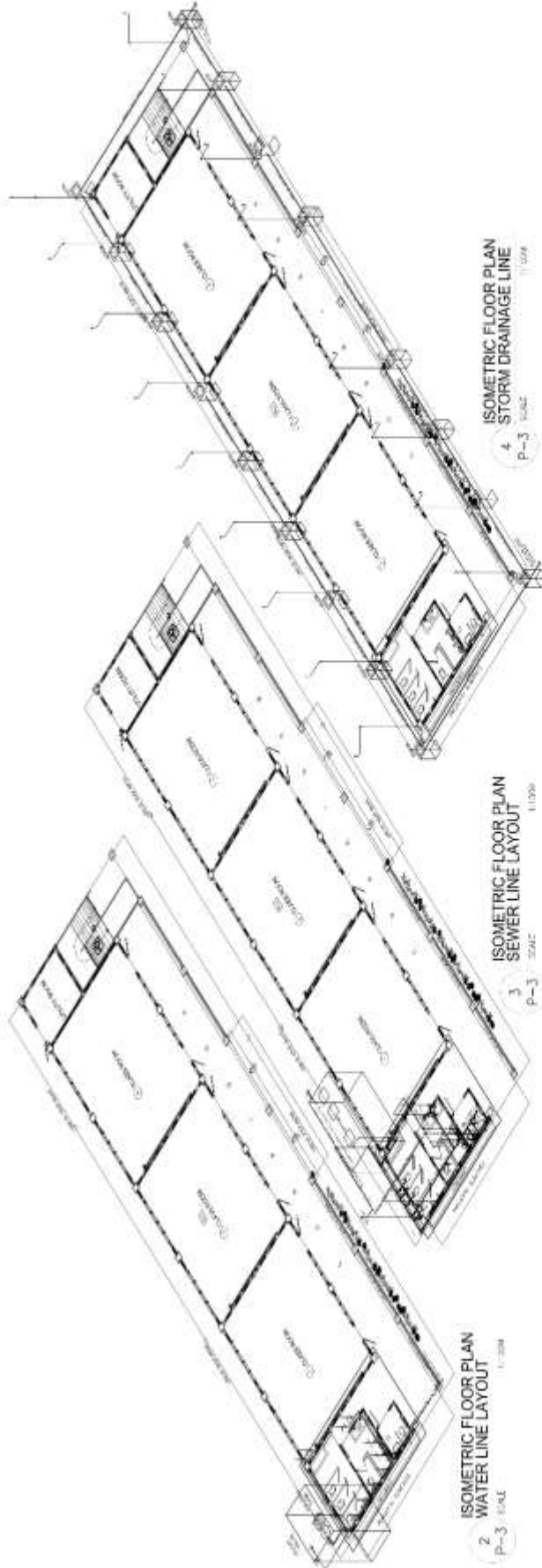

ISOMETRIC FLOOR PLAN STORM DRAINAGE LINE  
P-3 SCALE 1/8\"/>

 DEPARTMENT OF EDUCATION DIVISION OF PLANNING AND DESIGN	PROJECT NO. P-2 3
	PROJECT TITLE ONE (1) STOREY THREE (3) CLASSROOM SCHOOL BUILDING (WITH COMMERCIALS & ONE BAY)
DESIGNER JACQUES P. GILLARD ARCHITECT 1000 BROADVIEW AVE. TORONTO, ONT. M4W 1G7	ARCHITECT AMY D. S. PANGALA ARCHITECTURE INC. (CONSULTANT)
CHECKED BY JACQUES P. GILLARD ARCHITECT	APPROVED BY AMY D. S. PANGALA ARCHITECTURE INC. (CONSULTANT)
DATE 2014	DRAWN BY AMY D. S. PANGALA ARCHITECTURE INC. (CONSULTANT)



# RAIN WATER COLLECTOR PLAN

DATE:	06/16/2015
BY:	MS
CHECKED BY:	MS
ISSUE NO.:	01



INTERMEDIATE BULK CONTAINER  
(IBC)

SPECIFICATIONS:

CAPACITY 1,000L (1.00 Cu.m.)  
SIZE 1.00M X 1.00M X 1.00M  
WITH TUBE CAGE, PALLET AND  
2" DIA. DISCHARGE VALVE  
With Screen at Inlet.

**RAINWATER HARVESTING  
TANK (RWHT)**

1 RWHT-1a SCALE NTS

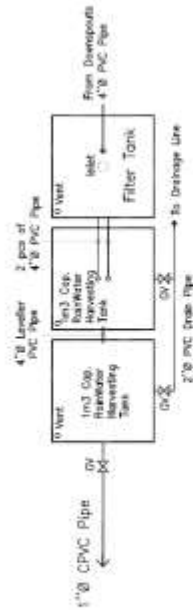

**Top View**

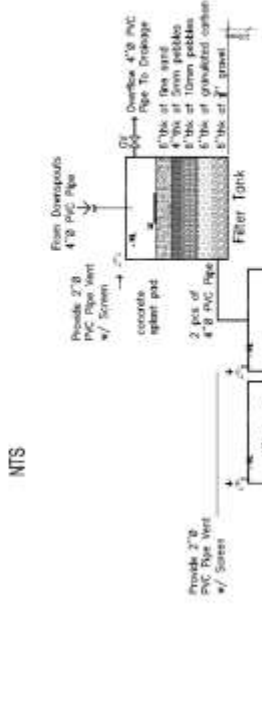

Note:  
Provide Male Adaptor w/ Locknut  
and Gasket w/ Adhesive to all connection  
of pipes to tank wall.

**Elevations**

**ELEVATION &  
TOP VIEW (RWHT)**

2 RWHT-1a SCALE NTS

		PROJECT NO.:	0
DESIGNED BY:	MANOJ K. PILLAI	PROJECT TITLE:	DEPARTMENT OF EDUCATION DepEd
DRAWN BY:	MANOJ K. PILLAI	DATE:	12/15/2014
CHECKED BY:	MANOJ K. PILLAI	SCALE:	AS SHOWN
APPROVED BY:	MANOJ K. PILLAI	ISSUED TO:	DEPARTMENT OF EDUCATION
PROJECT NO.:	0	ISSUED BY:	MANOJ K. PILLAI

NO.	REV.	DATE	BY	CHK.	APP.
1					

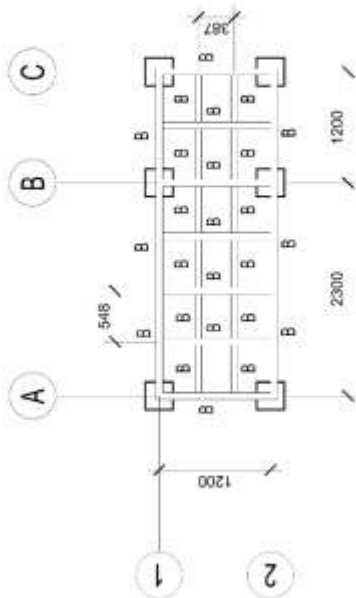

SCHEDULE OF MEMBERS & WELDS						
Mark	Members Size	Thickness mm	Welds			Remarks
			Length mm	L1	L2	
A	L100x100x6	6	Full Weld			Provide 6mm thick Plate Connector
B	L75x75x6	6	Full Weld			connections
C	L65x65x6	6	Full Weld			of members

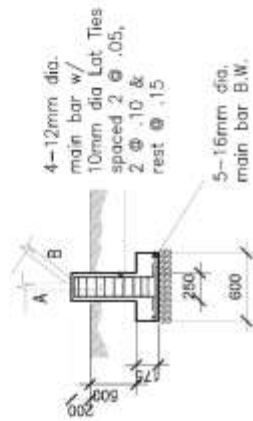

SQUARE CONCRETE PEDESTAL

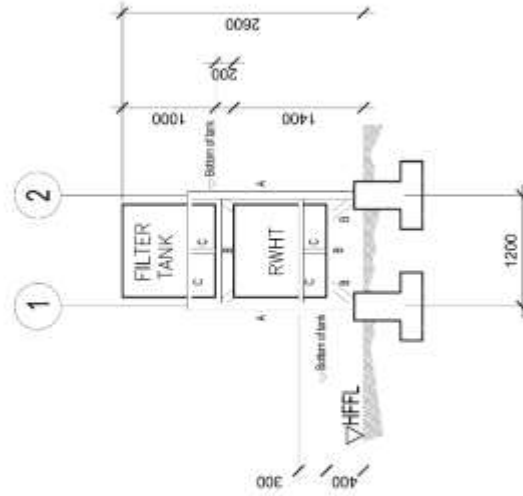
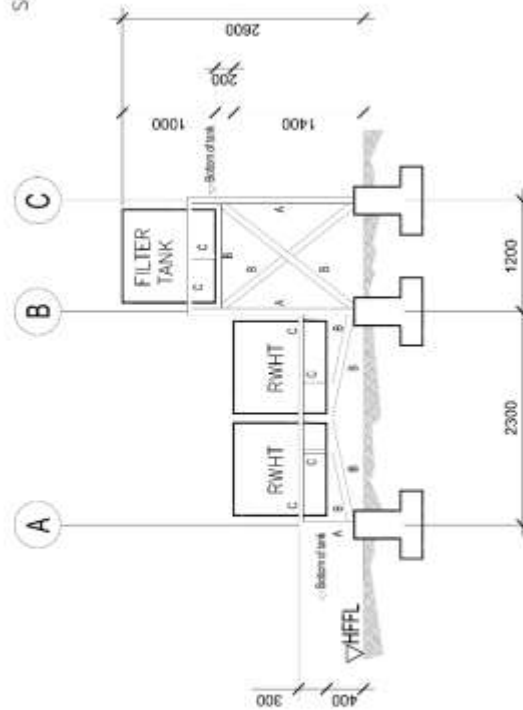

# RWHT SUPPORT

SCALE: 1 RWHT-1b NTS

	DESIGNED BY: <i>[Signature]</i> CHECKED BY: <i>[Signature]</i>	DRAWN BY: <i>[Signature]</i> CHECKED BY: <i>[Signature]</i>	PROJECT FILE: Rain Water Collector	PROJECT NO: DEPED-EDUCATION	SHEET NO: 0
	DEPARTMENT OF EDUCATION DIVISION OFFICE - CALABARZON	DEPARTMENT OF EDUCATION DIVISION OFFICE - CALABARZON	DEPARTMENT OF EDUCATION DIVISION OFFICE - CALABARZON	DEPARTMENT OF EDUCATION DIVISION OFFICE - CALABARZON	DEPARTMENT OF EDUCATION DIVISION OFFICE - CALABARZON

## *Section VIII. Bill of Quantities*

### **Notes on the Bill of Quantities**

#### **Objectives**

The objectives of the Bill of Quantities are:

- a. to provide sufficient information on the quantities of Works to be performed to enable Bids to be prepared efficiently and accurately; and
- b. when a Contract has been entered into, to provide a priced Bill of Quantities for use in the periodic valuation of Works executed.

In order to attain these objectives, Works should be itemized in the Bill of Quantities in sufficient detail to distinguish between the different classes of Works, or between Works of the same nature carried out in different locations or in other circumstances which may give rise to different considerations of cost. Consistent with these requirements, the layout and content of the Bill of Quantities should be as simple and brief as possible.

#### **Daywork Schedule**

A Daywork Schedule should be included only if the probability of unforeseen work, outside the items included in the Bill of Quantities, is high. To facilitate checking by the Entity of the realism of rates quoted by the Bidders, the Daywork Schedule should normally comprise the following:

- a. A list of the various classes of labor, materials, and Constructional Plant for which basic daywork rates or prices are to be inserted by the Bidder, together with a statement of the conditions under which the Contractor will be paid for work executed on a daywork basis.
- b. Nominal quantities for each item of Daywork, to be priced by each Bidder at Daywork rates as Bid. The rate to be entered by the Bidder against each basic Daywork item should include the Contractor's profit, overheads, supervision, and other charges.

#### **Provisional Sums**

A general provision for physical contingencies (quantity overruns) may be made by including a provisional sum in the Summary Bill of Quantities. Similarly, a contingency allowance for possible price increases should be provided as a provisional sum in the Summary Bill of Quantities. The inclusion of such provisional sums often facilitates budgetary approval by avoiding the need to request periodic supplementary approvals as the future need arises. Where such provisional sums or contingency allowances are used, the SCC should state the manner in which they will be used, and under whose authority (usually the Procuring Entity's Representative's).



The estimated cost of specialized work to be carried out, or of special goods to be supplied, by other contractors should be indicated in the relevant part of the Bill of Quantities as a particular provisional sum with an appropriate brief description. A separate procurement procedure is normally carried out by the Procuring Entity to select such specialized contractors. To provide an element of competition among the Bidders in respect of any facilities, amenities, attendance, etc., to be provided by the successful Bidder as prime Contractor for the use and convenience of the specialist contractors, each related provisional sum should be followed by an item in the Bill of Quantities inviting the Bidder to quote a sum for such amenities, facilities, attendance, etc.

### **Signature Box**

A signature box shall be added at the bottom of each page of the Bill of Quantities where the authorized representative of the Bidder shall affix his signature. Failure of the authorized representative to sign each and every page of the Bill of Quantities shall be a cause for rejection of his bid.

These Notes for Preparing a Bill of Quantities are intended only as information for the Procuring Entity or the person drafting the Bidding Documents. They should not be included in the final documents.

FOR BILL OF QUANTTES PLEASE REFER TO THE  
PROGRAM OF WORKS - BILL OF QUANTITIES  
FOUND IN SECTION VI - SPECIFICATIONS

## ***Section IX. Checklist of Technical and Financial Documents***

### **Notes on the Checklist of Technical and Financial Documents**

The prescribed documents in the checklist are mandatory to be submitted in the Bid, but shall be subject to the following:

- a. GPPB Resolution No. 09-2020 on the efficient procurement measures during a State of Calamity or other similar issuances that shall allow the use of alternate documents in lieu of the mandated requirements; or
- b. any subsequent GPPB issuances adjusting the documentary requirements after the effectivity of the adoption of the PBDs.

The BAC shall be checking the submitted documents of each Bidder against this checklist to ascertain if they are all present, using a non-discretionary “pass/fail” criterion pursuant to Section 30 of the 2016 revised IRR of RA No. 9184.

# Checklist of Technical and Financial Documents

*(Revised Checklist with reference to GPPB Resolution no. 15 - 2021)*

## I. TECHNICAL COMPONENT ENVELOPE

### *Class "A" Documents*

#### Legal Documents

- (a) Valid PhilGEPS Registration Certificate (Platinum Membership) (all pages) in accordance with Section 8.5.2 of the IRR;

#### Technical Documents

- (b) Statement of the prospective bidder of all its ongoing government and private contracts, including contracts awarded but not yet started, if any, whether similar or not similar in nature and complexity to the contract to be bid; **and**
- (c) Statement of the bidder's Single Largest Completed Contract (SLCC) similar to the contract to be bid, except under conditions provided under the rules *(Statement of On-going Contracts and SLCC should be supported by, but not limited to: Notice of Award; or Notice to Proceed; or Project Owner's Certificate of Final Acceptance issued by the owner other than the contractor) (ITB Clause 10.1 of Section III. Bid Data Sheet)*;
- (d) **and** Special PCAB License in case of Joint Ventures; **and** registration for the type and cost of the contract to be bid; **and**
- (e) Original copy of Bid Security. If in the form of a Surety Bond, submit also a certification issued by the Insurance Commission; **or** Original copy of Notarized Bid Securing Declaration; **and**
- (f) Project Requirements, which shall include the following:
- a. Organizational chart for the contract to be bid;
- b. List of contractor's key personnel (*e.g.*, Project Manager, Project Engineers, Materials Engineers, and Foremen), to be assigned to the contract to be bid, with their complete qualification and experience data;
- c. List of contractor's major equipment units, which are owned, leased, and/or under purchase agreements, supported by proof of ownership or certification of availability of equipment from the equipment

lessor/vendor for the duration of the project, as the case may be; **and**

- (g) Original duly signed Omnibus Sworn Statement (OSS); **and** if applicable, Original Notarized Secretary's Certificate in case of a corporation, partnership, or cooperative; or Original Special Power of Attorney of all members of the joint venture giving full power and authority to its officer to sign the OSS and do acts to represent the Bidder.

Financial Documents

- (h) The prospective bidder's computation of Net Financial Contracting Capacity (NFCC).

**Class "B" Documents**

- (i) If applicable, duly signed joint venture agreement (JVA) in accordance with RA No. 4566 and its IRR in case the joint venture is already in existence; **or**
- duly notarized statements from all the potential joint venture partners stating that they will enter into and abide by the provisions of the JVA in the instance that the bid is successful.

Other documentary requirements as required by the procuring entity

- (j) Affidavit of Site Inspection duly notarized **and**
- (k) Certificate of Site Inspection duly signed by the School Head or its Representative.  
(ITB Clause 3 of Section III. Bid Data Sheet)

NUMBER OF COPIES OF ELIGIBILITY+TECHNICAL COMPONENT DOCUMENTS IN SEPARATE ENVELOPE

- One (1) Original Copy  
 One (1) Additional Copy (Copy 1)  
 One (1) Copy in compact disc (CD) or Flash Drive (USB)  
(ITB Clause 16 of Section III. Bid Data Sheet)

*The softcopy or CD/Flash Drive copy of the Technical Component for Item "b" shall be in Microsoft Excel File format to facilitate Post-Qualification Evaluation. (ITB Clause 10.1 of Section III. Bid Data Sheet)*

**II. FINANCIAL COMPONENT ENVELOPE**

- (l) Original of duly signed and accomplished Financial Bid Form; **and**

Other documentary requirements under RA No. 9184

- (m) Original of duly signed Bid Prices in the Bill of Quantities; **and**

- (n) Duly accomplished Detailed Estimates Form, including a **summary sheet** indicating the unit prices of construction materials, labor rates, and equipment rentals used in coming up with the Bid; **and** *(ITB Clause 11.1 and 16 of Section III. Bid Data Sheet and also GCC Clause 11.1.i of Section V. Special Condition of the Contract )*
- (o) Cash Flow by Quarter.

NUMBER OF COPIES OF FINANCIAL COMPONENT DOCUMENTS IN SEPARATE ENVELOPE

- One (1) Original Copy  
 One (1) Additional Copy (Copy 1)  
 One (1) Copy in compact disc (CD) or Flash Drive (USB)  
*(ITB Clause 16 of Section III. Bid Data Sheet)*

*The softcopy or CD/Flash Drive copy of the Financial Component for Items "m" and "n" must be in Microsoft Excel File format to facilitate Bid Evaluation. (ITB Clause 11.1 of Section III. Bid Data Sheet)*

## **BIDDING FORMS**

- a. Bid Securing Declaration Form
- b. Bid Form
- c. Contract Agreement Form
- d. Omnibus Sworn Statement Form
- e. Performance Securing Declaration Form

## **Bid Securing Declaration Form**

*[shall be submitted with the Bid if bidder opts to provide this form of bid security]*

---

REPUBLIC OF THE PHILIPPINES)  
CITY OF \_\_\_\_\_) S.S.

### **BID SECURING DECLARATION** **Project Identification No.: *[Insert number]***

To: *[Insert name and address of the Procuring Entity]*

I/We, the undersigned, declare that:

1. I/We understand that, according to your conditions, bids must be supported by a Bid Security, which may be in the form of a Bid Securing Declaration.
2. I/We accept that: (a) I/we will be automatically disqualified from bidding for any procurement contract with any procuring entity for a period of two (2) years upon receipt of your Blacklisting Order; and, (b) I/we will pay the applicable fine provided under Section 6 of the Guidelines on the Use of Bid Securing Declaration, within fifteen (15) days from receipt of the written demand by the procuring entity for the commission of acts resulting to the enforcement of the bid securing declaration under Sections 23.1(b), 34.2, 40.1 and 69.1, except 69.1(f), of the IRR of RA No. 9184; without prejudice to other legal action the government may undertake.
3. I/We understand that this Bid Securing Declaration shall cease to be valid on the following circumstances:
  - a. Upon expiration of the bid validity period, or any extension thereof pursuant to your request;
  - b. I am/we are declared ineligible or post-disqualified upon receipt of your notice to such effect, and (i) I/we failed to timely file a request for reconsideration or (ii) I/we filed a waiver to avail of said right; and
  - c. I am/we are declared the bidder with the Lowest Calculated Responsive Bid, and I/we have furnished the performance security and signed the Contract.

IN WITNESS WHEREOF, I/We have hereunto set my/our hand/s this \_\_\_\_ day of *[month]* *[year]* at *[place of execution]*.

*[Insert NAME OF BIDDER OR ITS AUTHORIZED REPRESENTATIVE]*

*[Insert signatory's legal capacity]*

Affiant

### **[Jurat]**

*[Format shall be based on the latest Rules on Notarial Practice]*



**Bid Form for the Procurement of Infrastructure Projects**  
*[shall be submitted with the Bid]*

---

**BID FORM**

Date : \_\_\_\_\_

Project Identification No. : \_\_\_\_\_

To: *[name and address of Procuring Entity]*

Having examined the Philippine Bidding Documents (PBDs) including the Supplemental or Bid Bulletin Numbers *[insert numbers]*, the receipt of which is hereby duly acknowledged, we, the undersigned, declare that:

- a. We have no reservation to the PBDs, including the Supplemental or Bid Bulletins, for the Procurement Project: *[insert name of contract]*;
- b. We offer to execute the Works for this Contract in accordance with the PBDs;
- c. The total price of our Bid in words and figures, excluding any discounts offered below is: *[insert information]*;
- d. The discounts offered and the methodology for their application are: *[insert information]*;
- e. The total bid price includes the cost of all taxes, such as, but not limited to: *[specify the applicable taxes, e.g. (i) value added tax (VAT), (ii) income tax, (iii) local taxes, and (iv) other fiscal levies and duties]*, which are itemized herein and reflected in the detailed estimates,
- f. Our Bid shall be valid within the a period stated in the PBDs, and it shall remain binding upon us at any time before the expiration of that period;
- g. If our Bid is accepted, we commit to obtain a Performance Security in the amount of *[insert percentage amount]* percent of the Contract Price for the due performance of the Contract, or a Performance Securing Declaration in lieu of the the allowable forms of Performance Security, subject to the terms and conditions of issued GPPB guidelines<sup>2</sup> for this purpose;

---

<sup>2</sup> currently based on GPPB Resolution No. 09-2020

- h. We are not participating, as Bidders, in more than one Bid in this bidding process, other than alternative offers in accordance with the Bidding Documents;
- i. We understand that this Bid, together with your written acceptance thereof included in your notification of award, shall constitute a binding contract between us, until a formal Contract is prepared and executed; and
- j. We understand that you are not bound to accept the Lowest Calculated Bid or any other Bid that you may receive.
- k. We likewise certify/confirm that the undersigned, is the duly authorized representative of the bidder, and granted full power and authority to do, execute and perform any and all acts necessary to participate, submit the bid, and to sign and execute the ensuing contract for the [Name of Project] of the [Name of the Procuring Entity].
- l. We acknowledge that failure to sign each and every page of this Bid Form, including the Bill of Quantities, shall be a ground for the rejection of our bid.

Name: \_\_\_\_\_

Legal Capacity: \_\_\_\_\_

Signature: \_\_\_\_\_

Duly authorized to sign the Bid for and behalf of: \_\_\_\_\_

Date: \_\_\_\_\_

**Contract Agreement Form for the  
Procurement of Infrastructure Projects (Revised)**

*[not required to be submitted with the Bid, but it shall be submitted within ten (10) days after receiving the  
Notice of Award]*

---

**CONTRACT AGREEMENT**

THIS AGREEMENT, made this *[insert date]* day of *[insert month]*, *[insert year]* between *[name and address of PROCURING ENTITY]* (hereinafter called the “Entity”) and *[name and address of Contractor]* (hereinafter called the “Contractor”).

WHEREAS, the Entity is desirous that the Contractor execute *[name and identification number of contract]* (hereinafter called “the Works”) and the Entity has accepted the Bid for *[contract price in words and figures in specified currency]* by the Contractor for the execution and completion of such Works and the remedying of any defects therein.

NOW THIS AGREEMENT WITNESSETH AS FOLLOWS:

1. In this Agreement, words and expressions shall have the same meanings as are respectively assigned to them in the Conditions of Contract hereinafter referred to.
2. The following documents as required by the 2016 revised Implementing Rules and Regulations of Republic Act No. 9184 shall be deemed to form and be read and construed as part of this Agreement, *viz.*:
  - a. Philippine Bidding Documents (PBDs);
    - i. Drawings/Plans;
    - ii. Specifications;
    - iii. Bill of Quantities;
    - iv. General and Special Conditions of Contract;
    - v. Supplemental or Bid Bulletins, if any;
  - b. Winning bidder’s bid, including the Eligibility requirements, Technical and Financial Proposals, and all other documents or statements submitted;

Bid form, including all the documents/statements contained in the Bidder’s bidding envelopes, as annexes, and all other documents submitted (*e.g.*, Bidder’s response to request for clarifications on the bid), including corrections to the bid, if any, resulting from the Procuring Entity’s bid evaluation;

- c. Performance Security;

- d. Notice of Award of Contract and the Bidder's conforme thereto; and
  - e. Other contract documents that may be required by existing laws and/or the Procuring Entity concerned in the PBDs. **Winning bidder agrees that additional contract documents or information prescribed by the GPPB that are subsequently required for submission after the contract execution, such as the Notice to Proceed, Variation Orders, and Warranty Security, shall likewise form part of the Contract.**
3. In consideration for the sum of *[total contract price in words and figures]* or such other sums as may be ascertained, *[Named of the bidder]* agrees to *[state the object of the contract]* in accordance with his/her/its Bid.
  4. The *[Name of the procuring entity]* agrees to pay the above-mentioned sum in accordance with the terms of the Bidding.

IN WITNESS whereof the parties thereto have caused this Agreement to be executed the day and year first before written.

*[Insert Name and Signature]*  
*[Insert Signatory's Legal Capacity]*

*for:*

*[Insert Procuring Entity]*

*[Insert Name and Signature]*  
*[Insert Signatory's Legal Capacity]*

*for:*

*[Insert Name of Supplier]*

**Acknowledgment**

*[Format shall be based on the latest Rules on Notarial Practice]*

## Omnibus Sworn Statement (Revised)

*[shall be submitted with the Bid]*

---

REPUBLIC OF THE PHILIPPINES )  
CITY/MUNICIPALITY OF \_\_\_\_\_ ) S.S.

### AFFIDAVIT

I, [Name of Affiant], of legal age, [Civil Status], [Nationality], and residing at [Address of Affiant], after having been duly sworn in accordance with law, do hereby depose and state that:

1. *[Select one, delete the other:]*

*[If a sole proprietorship:]* I am the sole proprietor or authorized representative of [Name of Bidder] with office address at [address of Bidder];

*[If a partnership, corporation, cooperative, or joint venture:]* I am the duly authorized and designated representative of [Name of Bidder] with office address at [address of Bidder];

2. *[Select one, delete the other:]*

*[If a sole proprietorship:]* As the owner and sole proprietor, or authorized representative of [Name of Bidder], I have full power and authority to do, execute and perform any and all acts necessary to participate, submit the bid, and to sign and execute the ensuing contract for [Name of the Project] of the [Name of the Procuring Entity], as shown in the attached duly notarized Special Power of Attorney;

*[If a partnership, corporation, cooperative, or joint venture:]* I am granted full power and authority to do, execute and perform any and all acts necessary to participate, submit the bid, and to sign and execute the ensuing contract for [Name of the Project] of the [Name of the Procuring Entity], as shown in the attached [state title of attached document showing proof of authorization (e.g., duly notarized Secretary's Certificate, Board/Partnership Resolution, or Special Power of Attorney, whichever is applicable)];

3. [Name of Bidder] is not "blacklisted" or barred from bidding by the Government of the Philippines or any of its agencies, offices, corporations, or Local Government Units, foreign government/foreign or international financing institution whose blacklisting rules have been recognized by the Government Procurement Policy Board, **by itself or by relation, membership, association, affiliation, or controlling interest with another blacklisted person or entity as defined and provided for in the Uniform Guidelines on Blacklisting;**

4. Each of the documents submitted in satisfaction of the bidding requirements is an authentic copy of the original, complete, and all statements and information provided therein are true and correct;

5. [Name of Bidder] is authorizing the Head of the Procuring Entity or its duly authorized representative(s) to verify all the documents submitted;
  
6. *[Select one, delete the rest:]*  
*[If a sole proprietorship:]* The owner or sole proprietor is not related to the Head of the Procuring Entity, members of the Bids and Awards Committee (BAC), the Technical Working Group, and the BAC Secretariat, the head of the Project Management Office or the end-user unit, and the project consultants by consanguinity or affinity up to the third civil degree;  
*[If a partnership or cooperative:]* None of the officers and members of [Name of Bidder] is related to the Head of the Procuring Entity, members of the Bids and Awards Committee (BAC), the Technical Working Group, and the BAC Secretariat, the head of the Project Management Office or the end-user unit, and the project consultants by consanguinity or affinity up to the third civil degree;  
*[If a corporation or joint venture:]* None of the officers, directors, and controlling stockholders of [Name of Bidder] is related to the Head of the Procuring Entity, members of the Bids and Awards Committee (BAC), the Technical Working Group, and the BAC Secretariat, the head of the Project Management Office or the end-user unit, and the project consultants by consanguinity or affinity up to the third civil degree;
  
7. [Name of Bidder] complies with existing labor laws and standards; and
  
8. [Name of Bidder] is aware of and has undertaken the responsibilities as a Bidder in compliance with the Philippine Bidding Documents, which includes:
  - a. Carefully examining all of the Bidding Documents;
  - b. Acknowledging all conditions, local or otherwise, affecting the implementation of the Contract;
  - c. Making an estimate of the facilities available and needed for the contract to be bid, if any; and
  - d. Inquiring or securing Supplemental/Bid Bulletin(s) issued for the [Name of the Project].
  
9. [Name of Bidder] did not give or pay directly or indirectly, any commission, amount, fee, or any form of consideration, pecuniary or otherwise, to any person or official, personnel or representative of the government in relation to any procurement project or activity.
  
10. **In case advance payment was made or given, failure to perform or deliver any of the obligations and undertakings in the contract shall be sufficient grounds to constitute criminal liability for Swindling (Estafa) or the commission of fraud with unfaithfulness or abuse of confidence through misappropriating or converting any payment received by a person or entity under an obligation involving the duty to deliver certain goods or services, to the prejudice of the public and the government of the Philippines pursuant to Article 315 of Act No. 3815 s. 1930, as amended, or the Revised Penal Code.**

**IN WITNESS WHEREOF**, I have hereunto set my hand this \_\_\_ day of \_\_\_, 20\_\_ at \_\_\_\_\_, Philippines.

*[Insert NAME OF BIDDER OR ITS AUTHORIZED REPRESENTATIVE]*

*[Insert signatory's legal capacity]*

Affiant

**[Jurat]**

*[Format shall be based on the latest Rules on Notarial Practice]*

## Performance Securing Declaration (Revised)

*[if used as an alternative performance security but it is not required to be submitted with the Bid, as it shall be submitted within ten (10) days after receiving the Notice of Award]*

---

REPUBLIC OF THE PHILIPPINES)  
CITY OF \_\_\_\_\_ ) S.S.

### PERFORMANCE SECURING DECLARATION

Invitation to Bid: [Insert Reference Number indicated in the Bidding Documents]

To: [Insert name and address of the Procuring Entity]

I/We, the undersigned, declare that:

1. I/We understand that, according to your conditions, to guarantee the faithful performance by the supplier/distributor/manufacturer/contractor/consultant of its obligations under the Contract, I/we shall submit a Performance Securing Declaration within a maximum period of ten (10) calendar days from the receipt of the Notice of Award prior to the signing of the Contract.
2. I/We accept that: I/we will be automatically disqualified from bidding for any procurement contract with any procuring entity for a period of one (1) year for the first offense, or two (2) years **for the second offense**, upon receipt of your Blacklisting Order if I/We have violated my/our obligations under the Contract;
3. I/We understand that this Performance Securing Declaration shall cease to be valid upon:
  - a. issuance by the Procuring Entity of the Certificate of Final Acceptance, subject to the following conditions:
    - i. Procuring Entity has no claims filed against the contract awardee;
    - ii. It has no claims for labor and materials filed against the contractor; and
    - iii. Other terms of the contract; or
  - b. replacement by the winning bidder of the submitted PSD with a performance security in any of the prescribed forms under Section 39.2 of the 2016 revised IRR of RA No. 9184 as required by the end-user.

**IN WITNESS WHEREOF**, I/We have hereunto set my/our hand/s this \_\_\_\_ day of [month] [year] at [place of execution].

*[Insert NAME OF BIDDER OR ITS  
AUTHORIZED REPRESENTATIVE]*

*[Insert signatory's legal capacity]*

Affiant

**[Jurat]**

*[Format shall be based on the latest Rules on Notarial Practice]*



## ANNEXES

- ANNEX A. Certificate of Site Inspection and Affidavit of Site Inspection
- ANNEX B. Memorandum on Contractor's All Risk Insurance (CARI)
- ANNEX C. Sealing and Marking of Bids
- ANNEX D. Statement of the prospective bidder of all its ongoing government and private contracts, including contracts awarded but not yet started
- ANNEX E. Statement of the bidder's Single Largest Completed Contract (SLCC) similar to the contract to be bid
- ANNEX F. Revised PhilGEPS Certificate of Platinum Registration and Membership (*First Page*)



Republic of the Philippines  
Department of Education  
REGION VII – central visayas  
**SCHOOLS DIVISION OF NEGROS ORIENTAL**

**CERTIFICATE OF SITE INSPECTION**

DATE: \_\_\_\_\_

**MARCELO K. PALISPIS, JD, EdD**  
OIC - Assist. Schools Division Superintendent  
Chair, Bids and Awards Committee  
DepEd, Schools Division of Negros Oriental  
Dumaguete City

This is to certify that:

1. \_\_\_\_\_
2. \_\_\_\_\_

having represented themselves that he/she/they is/are the duly authorized representative/s of \_\_\_\_\_ with office address at \_\_\_\_\_ has/have inspected the actual site for the proposed infrastructure project: **CY 2022 Quick Response Fund (QRF) New Construction of School Buildings for Schools Affected by Calamities, Epidemics, Crises, & Catastrophes - Lot 2 (Manjuyod Central Elementary School, Negros Oriental).**

This certification is issued to the above named contractor / representative/s as required in the Bid Data Sheet - ITB Clause 3.

Issued by:

\_\_\_\_\_  
School Head / Representative

Republic of the Philippines )  
City of \_\_\_\_\_ ) s.s.

**AFFIDAVIT OF SITE INSPECTION**

I, {[Complete Name of Affiant]} of legal age, {[single/married/widower]}, Filipino and residing at {[Complete Home Address]}, after having been duly sworn by law, hereby depose and say:

1. That I am the {[State your company position / rank]} of {[State your company name]} with office address at {[State company's complete address]};
2. That I / our representative/s have inspected the actual site for the project **CY 2022 Quick Response Fund (QRF) New Construction of School Buildings for Schools Affected by Calamities, Epidemics, Crises, & Catastrophes - Lot 2 (Manjuyod Central Elementary School, Negros Oriental)**;
3. That I am making this statement as part of the bidding requirements of the Department of Education, Schools Division of Negros Oriental for the project, **CY 2022 Quick Response Fund (QRF) New Construction of School Buildings for Schools Affected by Calamities, Epidemics, Crises, & Catastrophes - Lot 2 (Manjuyod Central Elementary School, Negros Oriental)**;

IN WITNESS WHEREOF, I have hereunto set my signature this \_\_\_ day of \_\_\_\_\_, 20\_\_ at \_\_\_\_\_.

{[Complete Name of Affiant & Signature]}  
Affiant

SUBSCRIBE AND SWORN to before me this \_\_\_ day of \_\_\_\_\_, 20\_\_ at \_\_\_\_\_, affiant having exhibited to me his/her {[Valid Government ID, [ID No]]}. issued on \_\_\_\_\_, issued at \_\_\_\_\_.

{[Notary Public]}

Doc. No. \_\_\_\_  
Page No. \_\_\_\_  
Book No. \_\_\_\_  
Series of 20\_\_



Republika ng Pilipinas  
**Kagawaran ng Edukasyon**  
 Tanggapan ng Pangalawang Kalihim

**OUA MEMO 00-0121-0081**  
**MEMORANDUM**  
 22 January 2021

**For: Regional Directors**  
**Schools Division Superintendents**  
**Regional Engineers**  
**Division Engineers**  
**All Others Concerned**

**Subject: CONTRACTOR'S ALL RISK INSURANCE (CARI) FOR**  
**INFRASTRUCTURE PROJECTS**

The Office of the Undersecretary for Administration (OUA) requires all DepEd-implemented infrastructure projects to be covered by Contractor's All Risk Insurance (CARI) policy.

In line with this, Division and Project Engineers are hereby directed to ensure that the bidding documents include the CARI policy prior to the awarding of contract.

For all future correspondence and queries on the above-mentioned subject, please contact Ms. Czarina Suzette D. Santiago, Administrative Assistant II of EFD, through +63 917 676 0559 and email at [czarina.santiago@deped.gov.ph](mailto:czarina.santiago@deped.gov.ph)

For compliance of all concerned.

  
**ALAIN DEL B. PASCUA**  
 Undersecretary



**Office of the Undersecretary for Administration (OUA)**

*Administrative Service (AS), Information and Communications Technology Service (ICTS), Disaster Risk Reduction and Management Service (DRMMS), Bureau of Learner Support Services (BLSS), Baguio Teachers Camp (BTC), Central Security & Safety Office (CSSO)*

Department of Education, Central Office, Meralco Avenue, Pasig City  
 Rm 519, Mabini Bldg; Mobile: +639260320762; Tel: (+632) 86337203, (+632) 86376207  
 Email: [usec.admin@deped.gov.ph](mailto:usec.admin@deped.gov.ph); Facebook/Twitter @depeditayo

## SEALING AND MARKING OF BIDS

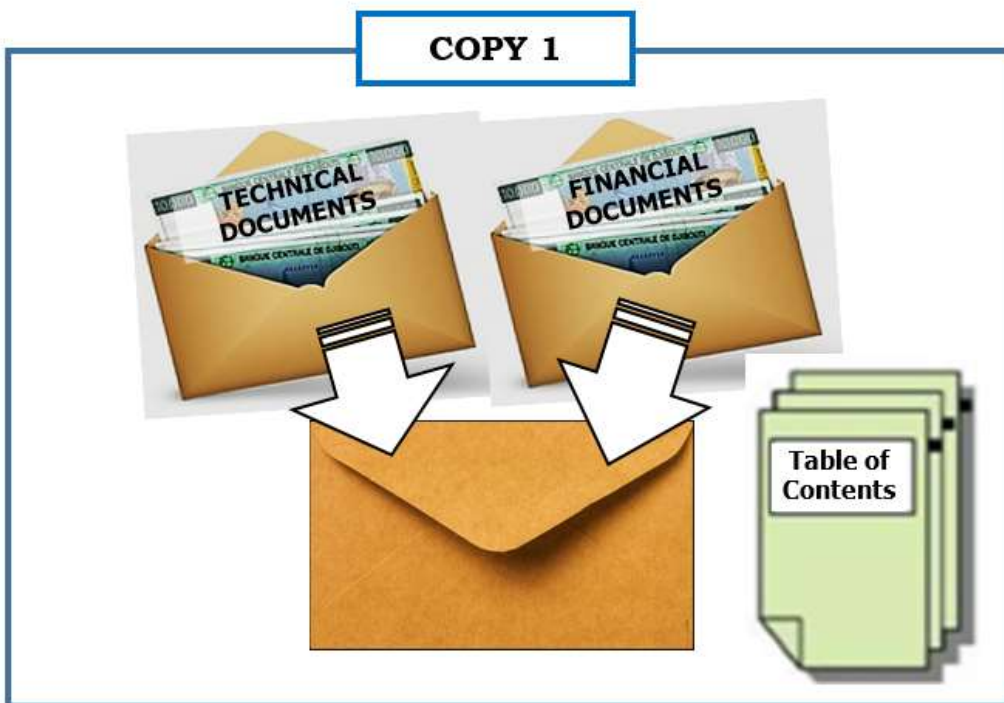
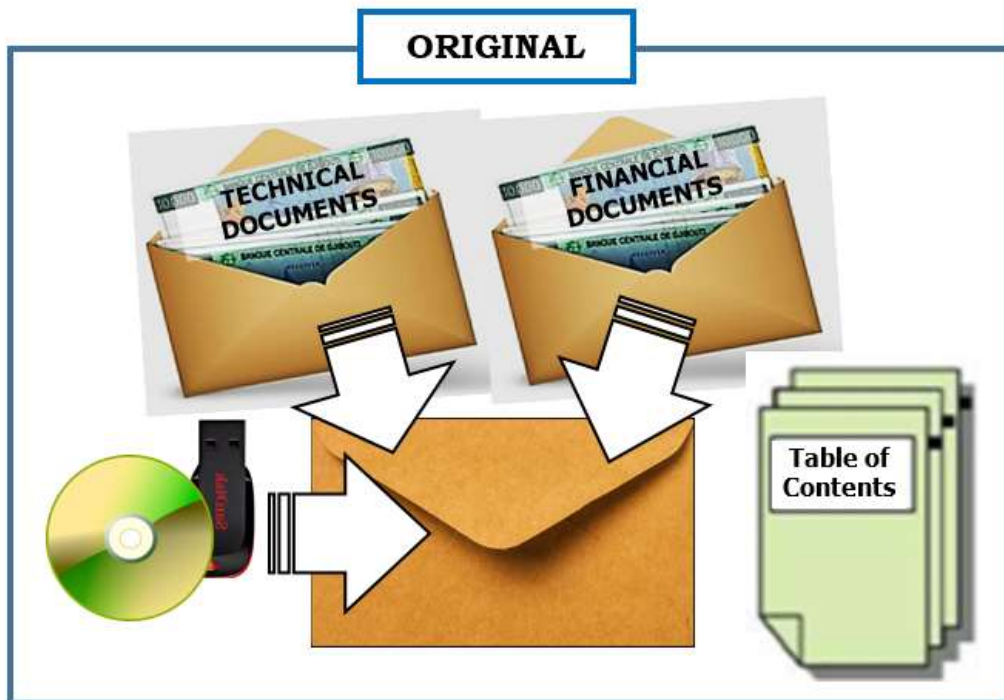

Unsealed or unmarked bid envelopes shall be rejected.



**Statement of all Ongoing Government & Private Construction Contracts including contracts awarded but not yet started**

Business Name : \_\_\_\_\_  
 Business Address : \_\_\_\_\_

Name of Contract / Location Project Cost / Contract Price	a. Owner's Name b. Address c. Contact No.	Nature of Work	Contractor's Role		a. Date Awarded b. Date Started c. Date of Completion	% of Accomplishment		Value of Unperformed Works
			Description	%		Planned	Actual	
<u>Government</u>								
<u>Private</u>								

Note: The bidder shall be able to support this statement with:  
 Duly signed Contracts, Agreements, Pos, Job Orders, Notice of Award, Notice of Proceed and/or Inspection and  
 Acceptance Reports issued by the owner / representative, duly signed CPES rating sheets and/or Certificate of Completion / Acceptance

Submitted by: \_\_\_\_\_  
 (Print Name and Signature)  
 Designation: \_\_\_\_\_  
 Date: \_\_\_\_\_

*This is one of the technical documents required to be in the Technical Component Envelope of a prospective bidder.*

**Statement of Single Largest Completed Government & Private Construction Contracts**

Business Name : \_\_\_\_\_  
 Business Address : \_\_\_\_\_

Name of Contract / Location Contract Completion Period in Calendar Days	a. Owner's Name b. Address c. Telephone	Nature of Work	Contractor's Role		a. Amount at Award b. Amount at Completion. c. Actual Contract Duration	a. Date Awarded b. Contract Effectivity c. Date Completed
			Description	%		
<u>Government</u>						
<u>Private</u>						

Note: The bidder shall be able to support this statement with:  
 Duly signed Contracts, Agreements, Pos, Job Orders, Notice of Award, Notice of Proceed and/or Inspection and  
 Acceptance Reports Issued by the owner / representative, duly signed CPES rating sheets and/or Certificate of Completion / Acceptance

Submitted by: \_\_\_\_\_  
 (Print Name and Signature)  
 Designation: \_\_\_\_\_  
 Date: \_\_\_\_\_

*This is one of the technical documents required to be in the Technical Component Envelope of a prospective bidder.*



Republic of the Philippines  
Department of Budget and Management  
PROCUREMENT SERVICE

CERTIFICATE OF PHILGEPS REGISTRATION  
(Platinum Membership)

*THIS IS TO CERTIFY THAT*

(NAME OF BIDDER)  
Address

is registered in the Philippine Government Electronic Procurement System (PhilGEPS) on (date of registration) pursuant to Section 8.5.2 of the Revised Implementing Rules and Regulations of Republic Act No. 9184, otherwise known as the Government Procurement Reform Act.

This further certifies that (name of the prospective bidder) has submitted the required eligibility documents in the PhilGEPS Supplier Registry as listed in Annex A which document is attached hereto and made an integral part hereof.

**For the purpose of updating this Certificate, all Class "A" eligibility documents covered by Section 8.5.2 of the Revised Implementing Rules and Regulations of Republic Act No. 9184 supporting the veracity, authenticity and validity of this Certificate shall remain current and updated. The failure by the prospective bidder to update this Certificate with the current and updated Class "A" eligibility documents shall result in the automatic suspension of its validity until such time that all of the expired Class "A" eligibility documents has been updated.**

**By submitting this Certificate, the Bidder certifies:**

- 1. the authenticity, genuineness, validity, and completeness of the copy of the original eligibility documents submitted;**
- 2. the veracity of the statements and information contained therein;**
- 3. that the Certificate is not a guaranty that the named registrant will be declared eligible without first being determined to be such for that particular bidding, nor is it evidence that the Bidder has passed the post-qualification stage; and**
- 4. that any finding of concealment, falsification, or misrepresentation of any of the eligibility documents submitted, or the contents thereof shall be a ground for disqualification from further participation in the bidding process, without prejudice to the imposition of appropriate administrative, civil and criminal penalty in accordance with the laws.**

This Certificate is valid until (date of expiration).

Issued this (date) day of (month), year.

This is a system-generated certificate. No signature is required.

Documentary Stamp Tax Paid 30.00  
Certificate Reference No:

(QR Code)

Page 1 of 3

Republic of the Philippines



Government Procurement Policy Board